



CONTROLS SUPPLY CHAIN
VALVES ACTUATORS INSTRUMENTATIONS

Instruction Manual

MIL 10000

Double Ported Top & Bottom Guided Control Valves



Purchase Order No : _____



The following instructions should be thoroughly reviewed and understood prior to installing, operating or performing maintenance on this equipment. Throughout the text, safety and/or caution notes will appear and must be strictly adhered to, otherwise, serious injury or equipment malfunction could result.





1.	Introduction.....	2
2.	General.....	3
3.	Unpacking.....	3
4.	Installation.....	3
5.	Air Piping.....	4
6.	Body Disassembly.....	4
7.	Maintenance / Repair.....	4
8.	Valve Body Reassembly.....	7
10	Parts List.....	9

Note: Easily replaceable Pressure gauges for Air sets and externally mounted Pressure gauges of positioners are normally dismantled, separately packed and bound to the actuator yoke as a precaution against transit damages. This may be noted while opening the boxes.

Warning: Do not lift large size valves by the actuator. Lifting lugs provided on the actuators are for lifting the actuator alone.

1. Introduction

The following instructions should be thoroughly reviewed and understood prior to installing, operating or performing maintenance

on this equipment. Throughout the text, safety and/or caution notes will appear and must be strictly adhered to, otherwise, serious injury or

equipment malfunction could result.

MIL has a highly skilled Aftermarket department available for start-up, maintenance and repair of our valves and component parts. Arrangements for availing their service can be made through your local representative or Aftermarket department. In addition, a regularly scheduled training program is conducted at our plant, to train customer service and instrumentation personnel in the operation, maintenance and application of MIL Control Valves and Accessories. Also when

performing maintenance, please ensure that only original MIL replacement parts are used. When specifying parts, always include Serial Number of the valve.

Caution: Skilled service personnel to be engaged for start up, maintenance and repair of the valve.

Caution: Always use original MIL replacement parts while performing maintenance.

2. General

The 10000 Series double ported control valves are designed to handle a wide variety of process applications. Construction features have been carefully selected to provide optimum performance. The concept of the top and bottom guided single seat valve was developed to improve the rigidity of the standard top guided valve for use at higher flow rates and pressure drops. The additional guiding reduces the vibration of the plug, which if severe enough, can use failure in valves with top guiding only. Double seated valves are inherently balanced and therefore enable economical actuation of larger valves than with

a single seated design.

All 10000 series bodies and plugs are invertible, so either air-to-open or air-to-close action can be obtained with the same spring diaphragm actuator.

These installation and maintenance instructions apply to all sizes and ratings of the MIL 10000 series control valves regardless of the type of trim used. Recommended spare parts required for maintenance are listed in parts reference of page 15. The model number, size, rating and serial number of valve are shown on the identification tag located on the actuator. Refer to Figure 1 to identify valve nomenclature.

3. Unpacking

Warning: Care must be exercised when unpacking the valve to prevent damage to the accessories and component parts. Should any problems arise, contact your local representative or MIL Aftermarket department. Do not remove end protection cover before installation.

4. Installation

Caution: Before installing the valve in the line, clean piping and flush the line to remove all foreign material such as welding chips, scale, oil, grease or dirt. End flange gasket surfaces must be thoroughly cleaned to ensure leak proof joints.

To allow in-line inspection, maintenance or removal of the valve without service interruption, provide a manually operated stop valve on either side of the MIL 10000 series valve with a manually operated throttling valve mounted in the by-pass line. (See figure 2)

Caution: The valve must be installed so that the controlled substance will flow through the valve in the direction indicated by the flow arrow located on the body.

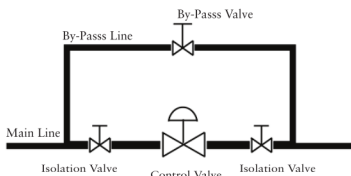

Figure 2

Caution: Where insulation of the valve body is required, do not insulate the valve bonnet. Take necessary protective measures for personal safety.

5. Air Piping

Unless otherwise specified, the connection to the actuator tubing shall be 1/4" NPT or 1/2" NPT. Use the tubing equivalent or higher to the connection size. Refer MIL valve specification sheet of respective valves for more details. All connection joints should be free of leaks.

Warning : Do not exceed supply pressure indicated on tag plate located on the yoke of the actuator.

Numbering System

1 st -	2 nd -	3 rd 1	4 th 0	5 th -	6 th -	7 th -
ACTUATOR TYPE		BODY SERIES		PLUG TYPE	TRIM CHARACTERISTICS	TRIM TYPE
20. Hand Operated 37. Direct Spring Diaphragm 38. Reverse Spring ⁽¹⁾ Diaphragm 67. Direct Piston Cylinder 68. Reverse Piston Cylinder 90. Electrical Actuator		10. Double Ported Top and Bottom Guided Control Valves		0. Undefined 1. Double Seat (Std) 2. Double Seat (Special)	0. Undefined 3. Equal % 6. On-Off 7. Linear 8. Lo-dB Linear	0. Undefined 2. Down Seating 4 Up Seating 6. Down Seating (Soft Seat)

⁽¹⁾ : For soft seated valves requiring "Air fail close action". Soft seat is applicable only for linear and on-off characteristics.

6. Body Disassembly

Caution: New packing & gaskets sets should be on hand before disassembling the valve, since it is recommended that new packing & gaskets be used during reassembly.

Warning: Prior to performing maintenance on the valve, isolate the valve, vent the process pressure, shut off supply and signal air lines to the actuator. In addition, it is recommended that the bonnet, body and bottom flange be marked in relation to each other so that the same orientation can be maintained during reassembly.

Access to the internal components of the body should be accomplished with the actuator removed. To remove the actuator from the body, refer to the appropriate actuator instructions.

- A. Remove Stem lock nuts and travel indicator
- B. Remove packing flange nuts (2), packing flange (3), packing follower (18) from the bonnet
- C. Remove body stud nuts (6, 7) from around the bonnet and bottom flange.
- D. Remove bonnet (5) bottom flange (11) gaskets (12) and plug and stem sub-assembly (1, 9) from the body.
- E. Remove packing (17) and packing spacer (16) from the bonnet.
- F. Inspect all parts for wear and service damage. If bushings (15) must be removed from the bonnet or bottom flange, refer to section 7.2. After determining the maintenance required, proceed to the appropriate section of these instructions.

Note : If a new body gasket 12, is not available, care must be taken to preserve the old gasket for reuse.

7. Maintenance & Repair

The purpose of this section is to assist maintenance personnel by suggesting methods of component maintenance which is largely dependent on the tools and machine shop equipment available. Each section should be read and understood before proceeding.

7.1 Seat Ring Removal

Threaded seat rings (13, 14) are installed tightly at the point of manufacture and after years of service they are often difficult to remove. To facilitate removal, seat ring wrenches can be fabricated to engage the seat ring lugs and adapted to a shock wrench (see figure 3). If the seat ring is exceptionally resistant to removal the application of heat or penetrating oil should be helpful.

Caution: When using heating devices, ensure that proper safety practices are observed. Such items as flammability and toxicity of the controlled substance must be considered and proper precautions taken.

7.2 Bushing Removal

The bushings (15) are press fitted into the bonnet and bottom flange, and do not normally require replacement. However, should replacement be required, they can be pulled or machined out. When machining the bushings out, care must be taken to maintain proper dimensions and tolerances.

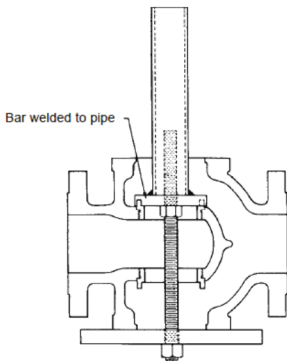

figure 3

7.3 Lapping Seats

Lapping is the process of working the valve plug against the seat ring with an abrasive to produce a close fit. When valve leakage becomes excessive, lapping becomes necessary. The plug and seat ring seating surfaces should be free of large dents, scratches and the contact surfaces of the seats should be as narrow as possible. This may require dressing both parts in a lathe. The seating surfaces make an angle of 30 degrees with the axis of the plug (See figure 4). For the lapping operation, a good grade of fine grinding compound is required. The compound should be mixed with a small quantity of lubricant, such as graphite. This will slow the cutting rate and prevent tearing of the seating surfaces. The amount of lapping required depends on the materials, condition of seating surfaces and accuracy of machining. If a short period of lapping does not visibly improve seating there is usually no advantage in continuing, as too much lapping may result in rough seats. The only remedy is replacement or re-machining of one or both parts. When lapping new plug and seat ring, begin with medium compound and finish with fine.

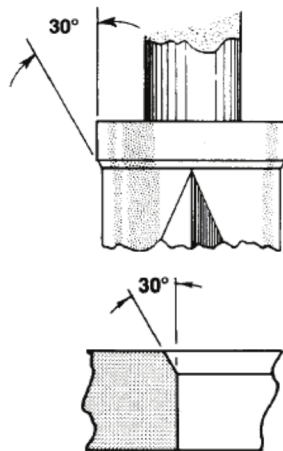

figure 4

Caution : Before lapping plug and stem must be true (see pinning operation, section 7.4).



Note : Seat repair in a double seated valve is critical. In a new valve the distance between the upper and lower seat ring seats is established with a special reamer, and only lapping is required to make both ports close simultaneously. In the field, it is best to lap the seats first. If one of the seats is damaged beyond what is repairable by lapping, care must be taken to maintain the original distance between the seats on both the plug and seat rings. Therefore, when machining one seat of the plug or one seat ring the other must be machined in exactly the same way.

- A. Clean body gasket surface areas.
- B. When the seats have been removed, ensure that the sealing surfaces in the body bridge and the threads are thoroughly cleaned.

Note : A sealant compatible with the process should be applied sparingly, to the seat ring threads and sealing shoulder.

- C. Install and tighten seat rings using fabricated wrench used for removal. (See figure 3).

Caution: not over tighten. Do not strike seat ring lugs, this could distort the seat ring resulting in unwarranted seat leakage.

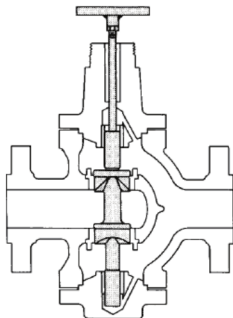

figure 5

- D. Install bottom flange (11), ensuring bottom bushing (15) is in place and secure to the body using 4 body stud nuts (6, 7) spaced equally apart. Fasten the bottom flange to the body using only slight pressure and tighten evenly.

Caution : Do not tighten nuts to torque specifications at this time. The bottom flange is used temporarily for guiding purposes.

- E. Apply Lapping compound at several spots equally spaced around the seating areas of the plug.
- F. Insert the stem and plug assembly carefully into the body until it is seated.
- G. Place bonnet (5) on the body and using 4 body stud nuts (6, 7), spaced equally apart, fasten to the body using only slight pressure and tighten evenly.

Caution: Do not tighten nuts to torque specifications at this time. The bonnet is used temporarily for guiding purposes.

- H. Insert two or three pieces of packing (17) into the packing box to assist in guiding the stem and plug during lapping.
- I. Screw a drilled and tapped rod with a tee handle onto the plug stem and secure with a lock nut. (See figure 5).

Note : As an alternative, drill a hole through a flat piece of steel and fasten to the plug stem using two lock nuts.

- J. Apply a slight pressure on the stem, rotating the stem in short oscillating strokes eight to ten times.

Note : The plug should be lifted and turned 90 degrees before repeating step 10. This intermittent lifting is required to keep the plug and seat ring concentric during lapping. After completion of the lapping operation, remove body stud nuts (6, 7) from the bonnet (5) and bottom flange (11).

- K. Remove bonnet (5) and bottom flange (11)
- L. The seat rings, plug and internal components of the valve must be cleaned of all lapping compound in preparation for reassembly.

7.4.Plug Stem Pinning

Valve plug and stem assemblies are normally furnished as a complete assembly in which case the installation involves no problem. It is only necessary to lap the plug and seat ring and assemble the valve. If it is necessary to replace the plug it is recommended that a new stem be used. If the old stem must be used, it is necessary to determine if the stem will be long enough since the stem will require cutting. If the stem does not engage the actuator stem by a minimum of one stem diameter, the old stem should not be used. If it does engage a minimum of one stem diameter, proceed as follows.

- A. Using a drift punch, drive out the old pin

Note: While replacing packing, replace the upper packing set completely

Caution : Valve must be isolated and the pressure vented before performing packing box maintenance.

Proceed as follows :

- A. Disconnect the actuator stem from the valve to maintain a gap to insert the packing set
 B. Loosen and remove packing flange nuts (2).
 C. Raise packing flange (3), and packing follower (18) up the valve stem.

Note: They may be taped in place to keep them out of the way before proceeding.

- D. By means of a hooked instrument, remove packing (17) ensuring not to damage the sealing surfaces of the packing box or plug stem.
 E. Replace packing (17) referring to Figure 9 for correct amount of packing to place above the spacer.

Note : Assemble and compress rings one at a time into packing box. If rings are skive cut, the skive cut of each packing ring must be placed about 120 degrees apart.

Note : If it is necessary to drill out the pin a drill somewhat smaller than the pin should be used and the remainder of the pin driven out.

- (8).
 B. Unscrew the plug from the stem (counter clock-wise).
 C. Cut off the stem directly above the pin hole. (See figure 6).
 D. Rethread the stem the original amount.

Note : The area of the plug stem marked in figure 8, serves as a guide and must be checked ensure a close fit in the valve plug.

- E. Screw the stem solidly into the plug.

Note : : This can be checked by measuring the depth of the pilot recess in the plug (X in figure 8), and making a reference mark on the stem the same distance from the thread. When properly assembled, the reference mark should be flush with the end of the guide section.

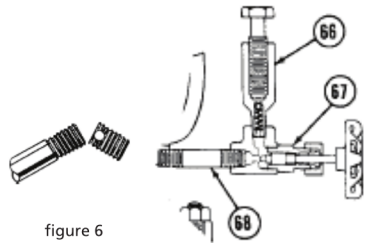
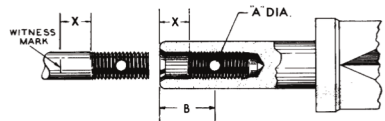

figure 6

figure 7



Stem Dia	Hole Dia. "A"	"B"	"X"
½	0.188	1.25	0.50
½	0.219	1.562	0.62

figure 8



- F. Place the plug guide on a V block and using a suitable size drill, drill the stem using the hole in the plug as a guide.
- G. Remove any burrs from the plug guide by making a slight counter bore.
- H. Select the correct size pin, apply a small

Note : The pin must be recessed approximately 1/16" below the plug guide surface.

amount of grease on it and press into the hole.

- I. After the plug has been pinned it should be placed in a lathe to ensure it is running true. If it is not, strike the plug with a soft faced mallet to straighten.

Note : The plug should be placed in a collet with the plug guide against it and the plug should be struck.

7.5 Packing Box

Packing box maintenance is one of the principal actions in routine servicing. Tightness of the packing is maintained by packing compression. Compression is achieved by evenly tightening the packing flange nuts (2) against the packing flange (3). Care must be taken not to over tighten as this could prevent smooth operation of the valve. If all compression is used up and the valve leaks, then new packing is required. The packing is available as a set of lower and upper packing. The height of the lower and upper packing set is same for standard packing. Due to the difference in the height for Eco-lock packing, the packing sets are labeled as lower packing and upper packing. The upper packing set will be larger than lower packing set for Eco-lock.

Note: For any type packing do not change the sequence of packing arrangement. Use the packing as a set only.

Note: MIL Ecolock packing (Fig 10) is a high performance system to keep fugitive emissions within allowable limits. The packing is provided with the inner packing and outer packing as a set. It consists of V and double V packing rings with varying density, which is designed to prevent fugitive emission from the packing effectively.

Caution: For Eco-lock packing, inner and outer packing to be replaced as a set only.

- F. Replace packing follower (18) and packing flange (3).
- G. Replace and tighten packing stud nuts.

Caution: Do not over-tighten.

- H. Put valve back in service and tighten packing only as much as is necessary to stop leaking.

Note: In an emergency, string packing may be used as a temporary repair only. It must be replaced with the correct packing as soon as possible.

Note: A spring loaded follower assembly is used to maintain a constant load on the packing, and is necessary for thermal cycling applications. As the definition of thermal cycling can vary, and processes are potentially subject to unpredicted thermal gradients. Both standard and Eco-Lock systems are available with the spring loaded follower (Figure 11).

Caution: Packing box should be clean and free of burrs, rust, and any foreign matter. Parts can be cleaned with denatured alcohol.

7.6 Special Plug construction (For class III and above leakage)

For valves with leakage class III and above, an adjustable type plug is provided. This is to overcome the difficulty in simultaneous closure of both the ports.

The upper plug is maintained in the closed position and lower plug is adjusted such that the lower plug seats in the lower port and then the lower plug is locked using the lock nut (Figure 11). Only down seating is provided for such construction, to facilitate the adjustments from bottom. Hence, for air-to-open action, Reverse type actuator is opted and for air to close action, direct actuator is opted.

8. VALVE BODY REASSEMBLY (For Valve <= Class II leakage)

It is possible to change the valve from down seating to up seating or vice versa. However, the plug stem must be repinned to the opposite end of the plug. (If at all possible, a new stem should be used). Then, simply invert the valve body and re-assemble. The tolerances and clearances explained in this instruction apply to either seating direction.

After completion of the required maintenance, the valve should be reassembled using the following procedures.

Note : If any of the following steps were completed during maintenance proceed to the next step. If the bonnet, body and bottom flange were marked in relation to each other, remember to align these marks to obtain the same orientation.

- A. Clean all gasket surfaces.
- B. Apply a small amount of sealant to the seat ring threads and sealing shoulder and install.
- C. Using seat ring wrench, fabricated for removal, tighten seat ring only enough to ensure a seal.

Caution : Do not over tighten. Do not strike the seat ring lugs. This could distort the seat ring, resulting in unwarranted seat leakage.

Note : Valve seats must be lapped before final assembly (See section 6.3).

- D. Install bottom flange gasket (12) bottom flange (11) and loosely install body stud nuts (6, 7). Install stem and plug assembly (1, 9).

Caution: The upper plug must be installed so that the larger of the two V-notches in that plug is in line with the inlet of the valve.

- E. Install bonnet gasket (12), bonnet (5) and loosely install body stud nuts (6, 7).

Note : For ease of accessibility the bonnet should be positioned so that the packing flange studs are at right angles to the flow center line.

Caution: Refer to figure 10 for proper bolt torque and tightening sequence specifications. Additionally the plug must be stroked manually while evenly tightening the body stud nuts (6, 7) around both bonnet and bottom flange to ensure proper alignment and prevent binding between the plug guides and the bushings.

- F. Insert packing (17) and packing spacer (16).
- G. Install packing follower (18) and packing flange.
- H. Install packing flange stud nuts (2).

Caution: Do not tighten at this time. When placed in service they should be tightened only enough to stop leaking.

- I. Install stem lock nuts and travel indicator on plug stem.
- J. Proceed to the appropriate actuator instructions for actuator to body assembly.

Valve Size (Inch)	ASME Rating Class	Stud Size	Torque (Nm)
¾ to 2½	600	½ - 13	31
3	300	½ - 13	31
3 to 8	600	5/8 - 13	60
10	600	7/8 - 13	168
12	600	11/8 - 13	344

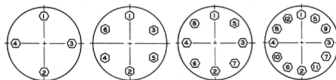

Bolting Torques And Tightening Sequence

Parts Reference

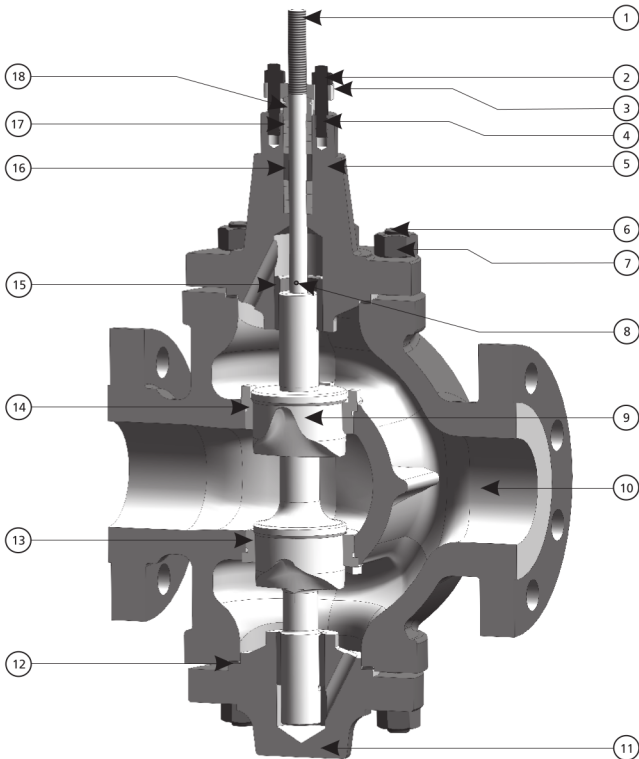

DRAWING Ref No.	PART NAME	DRAWING Ref No.	PART NAME
1	Plug Stem	11	Blind Flange
2	Packing Flange Nut	12	Body Gasket
3	Packing Flange	13	Lower Seat Ring
4	Packing Flange Stud	14	Upper Seat Ring
5,10	Bonnet, Body	15	Guide Bush
6	Body Stud	16	Packing Spacer
7	Body Nut	17	Packing
8	Plug Pin	18	Packing Follower
9	Plug		