

Automatic Recirculation Valve

MIL 90000



CONTROLS SUPPLY CHAIN
VALVES ACTUATORS INSTRUMENTATIONS

Installation/Operating Manual





CONTROLS SUPPLY CHAIN
VALVES ACTUATORS INSTRUMENTATIONS

Legal information/Copyright

Installation/Operating Manual MIL 90000

Original operating manual

All rights reserved. The contents provided herein must neither be distributed, copied, reproduced, edited or processed for any other purpose, nor otherwise transmitted, published or made available to a third party without the manufacturer's express written consent.

Subject to technical modification without prior notice.



Contents

	Glossary	5
1	General.....	6
	1.1 Principles	6
	1.2 Target group.....	6
	1.3 Other applicable documents.....	6
	1.4 Symbols	6
	1.5 Key to safety symbols/markings.....	6
2	Safety	8
	2.1 General.....	8
	2.2 Intended use	8
	2.3 Personnel qualification and training.....	9
	2.4 Consequences and risks caused by non-compliance with this manual	9
	2.5 Safety awareness	9
	2.6 Safety information for the operator/user	9
	2.7 Safety information for maintenance, inspection and installation	10
	2.8 Unauthorised modes of operation.....	10
3	Transport/Storage/Disposal	11
	3.1 Checking the condition upon delivery	11
	3.2 Transport.....	11
	3.3 Storage/preservation	12
	3.4 Return to supplier.....	12
	3.5 Disposal	12
4	Description of the Valve	13
	4.1 General description	13
	4.2 Product information.....	13
	4.2.1 Product information as per Pressure Equipment Directive 2014/68/EU (PED).....	13
	4.2.2 Product information as per Regulation No. 1907/2006 (REACH)	13
	4.3 Designation.....	14
	4.4 Marking.....	15
	4.5 Name plate.....	16
	4.6 Design details.....	16
	4.7 Function	17
	4.8 Scope of supply.....	18
	4.9 Noise characteristic.....	18
5	Installation at Site	19
	5.1 General information/Safety regulations	19
	5.2 Installation position.....	19
	5.3 Preparing the valve	20
	5.4 Piping	20
	5.4.1 Flange connection.....	20
6	Commissioning/Start-up/Shutdown	21
	6.1 Commissioning/Start-up.....	21
	6.1.1 Prerequisites for commissioning/start-up	21
	6.1.2 Starting up the system.....	21
	6.2 Operating limits.....	21
	6.2.1 Pressure/temperature ratings.....	21
	6.2.2 Ambient temperature.....	22
	6.3 Shutdown.....	22
	6.3.1 Measures to be taken for shutdown	22
7	Servicing/Maintenance	23
	7.1 Safety regulations.....	23



7.2	7.2 Servicing/Inspection.....	23
	7.2.1 Supervision of operation	23
	7.2.2 Inspection work.....	24
	7.2.3 Dismantling the valve	24
	7.2.4 Assembling the valve	25
7.3	7.3 Tightening torques.....	26
7.4	7.4 Returning to service	27
8	8 Trouble-shooting.....	28
9	9 Related Documents	30
	9.1 General assembly drawing with list of components	30
	9.2 Dimensions and weights	32
10	10 EU Declaration of Conformity for MIL 90000.....	34
11	11 Certificate of Decontamination.....	35
	Index	36



Glossary

Certificate of decontamination

A certificate of decontamination is enclosed by the customer when returning the product to the manufacturer to certify that the product has been properly drained to eliminate any environmental and health hazards arising from components in contact with the fluid handled.

Pressure Equipment Directive 2014/68/EU (PED)

The 2014/68/EU Directive sets out the requirements to be met by pressure equipment intended to be placed on the market in the European economic area.

1 General

1.1 Principles

This operating manual is valid for the type series and variants indicated on the front cover.

The operating manual describes the proper and safe use of this equipment in all phases of operation.

In the event of damage, immediately contact your nearest KSB sales organisation responsible to maintain the right to claim under warranty.

1.2 Target group

This operating manual is aimed at the target group of trained and qualified specialist technical personnel.

1.3 Other applicable documents

Table 1: Overview of other applicable documents

Document	Contents
Type series booklet	Description of the valve
Data sheet	Description of the technical data for the automatic recirculation valve
General assembly drawing	Sectional drawing with list of components
Dimensional drawing	Dimensions of the valve



1.4 Symbols

Table 2: Symbols used in this manual





Symbol	Description
✓	Conditions which need to be fulfilled before proceeding with the step-by-step instructions
▷	Safety instructions
⇒	Result of an action
⇔	Cross-references
1. 2.	Step-by-step instructions
	Note Recommendations and important information on how to handle the product

1.5 Key to safety symbols/markings

Table 3: Definition of safety symbols/markings

Symbol	Description
 DANGER	DANGER This signal word indicates a high-risk hazard which, if not avoided, will result in death or serious injury.
 WARNING	WARNING This signal word indicates a medium-risk hazard which, if not avoided, could result in death or serious injury.
CAUTION	CAUTION This signal word indicates a hazard which, if not avoided, could result in damage to the machine and its functions.



Symbol	Description
	Explosion protection This symbol identifies information about avoiding explosions in potentially explosive atmospheres in accordance with EU Directive 2014/34/EU (ATEX).
	General hazard In conjunction with one of the signal words this symbol indicates a hazard which will or could result in death or serious injury.
	Electrical hazard In conjunction with one of the signal words this symbol indicates a hazard involving electrical voltage and identifies information about protection against electrical voltage.
	Machine damage In conjunction with the signal word CAUTION this symbol indicates a hazard for the machine and its functions.



2 Safety

2.1 General

- This operating manual contains general installation, operating and maintenance instructions that must be observed to ensure safe operation of the system and prevent personal injury and damage to property.
- Comply with all the safety instructions given in the individual sections of this operating manual.
- The operating manual must be read and understood by the responsible specialist personnel/operators prior to installation and commissioning.
- The contents of this operating manual must be available to the specialist personnel at the site at all times.
- Information and markings attached directly to the product must always be complied with and kept in a perfectly legible condition at all times. This applies to, for example:
 - Manufacturer
 - Type designation
 - Pressure class
 - Nominal size
 - Flow direction arrow
 - Year of construction
 - Valve body material
- The operator is responsible for ensuring compliance with all local regulations not taken into account.
- The design, manufacture and testing of the valve are subject to a QM system to DIN EN ISO 9001 as well as the current regulations and directives for pressure equipment.
- Bear in mind that valves exposed to creep-rupture conditions have a limited service life and have to meet the applicable regulations stipulated in the technical codes.
- In the case of customised special variants, further restrictions may apply with regard to the operating mode and service life. Refer to the relevant sales documentation for applicable limitations.
- The operator is responsible for any eventualities or incidents which may occur during installation performed by the customer, operation and maintenance.

2.2 Intended use

- Only operate valves which are in perfect technical condition.
- Do not operate the valve in partially assembled condition.
- Only use the valve for fluids specified in the product literature. Take the design and material variant into account.
- Only operate the valve within the operating limits described in the other applicable documents.
- The valve's design and rating are based on predominantly static loading in accordance with the codes applied. Consult the manufacturer if the valve is subjected to dynamic loads or any other additional influences.
- Consult the manufacturer about any other modes of operation not described in the product literature.
- Do not use the valve as a foothold.



2.3 Personnel qualification and training

- All personnel involved must be fully qualified to transport, install, operate, maintain and inspect the product this manual refers to and be fully aware of the interaction between the valve and the system.
- The responsibilities, competence and supervision of all personnel involved in transport, installation, operation, maintenance and inspection must be clearly defined by the operator.
- Deficits in knowledge must be rectified by means of training and instruction provided by sufficiently trained specialist personnel. If required, the operator can commission the manufacturer/supplier to train the personnel.
- Training on the valve must always be supervised by specialist technical personnel.

2.4 Consequences and risks caused by non-compliance with this manual

- Non-compliance with these operating instructions will lead to forfeiture of warranty cover and of any and all rights to claims for damages.
- Non-compliance can, for example, have the following consequences:
 - Hazards to persons due to electrical, thermal, mechanical and chemical effects and explosions
 - Failure of important product functions
 - Failure of prescribed maintenance and servicing practices
 - Hazard to the environment due to leakage of hazardous substances

2.5 Safety awareness

In addition to the safety information contained in this operating manual and the intended use, the following safety regulations shall be complied with:

- Accident prevention, health regulations and safety regulations
- Explosion protection regulations
- Safety regulations for handling hazardous substances
- Applicable standards, directives and laws

2.6 Safety information for the operator/user

- Actuator-operated valves are intended for use in areas which cannot be accessed by unauthorised persons. Operation of these valves in areas accessible to unauthorised persons is only permitted if appropriate protective devices are fitted at the site. This must be ensured by the operator.
- Fit protective equipment (e.g. contact guards) supplied by the operator for hot, cold or moving parts, and check that the equipment functions properly. Do not touch rotating parts.
- Do not remove any protective equipment (e.g. contact guards) during operation.
- Provide the personnel with protective equipment and make sure it is used.
- Contain any leakage of hazardous fluids (e.g. explosive, toxic, hot) so as to avoid any danger to persons and the environment. Adhere to all relevant laws.
- Eliminate all electrical hazards. (In this respect refer to the applicable national safety regulations and/or regulations issued by the local energy supply companies.)



2.7 Safety information for maintenance, inspection and installation

- Modifications or alterations of the valve require the manufacturer's prior consent.
- Use only original spare parts or parts/components authorised by the manufacturer. The use of other parts/components can invalidate any liability of the manufacturer for resulting damage.
- The operator ensures that maintenance, inspection and installation are performed by authorised, qualified specialist personnel who are thoroughly familiar with the manual.
- Use suitable tools in accordance with EN 13463-1 for maintenance, inspection and installation.
- Carry out work on the valve during standstill only.
- The valve body must have cooled down to ambient temperature.
- The pressure in the valve body must have been released and the valve must have been drained.
- When taking the valve out of service always adhere to the procedure described in the manual.
- Decontaminate valves which handle fluids posing a health hazard.
- Protect the valve body and body bonnet/cover from any impacts.
- As soon as the work has been completed, re-install and re-activate any safety-relevant devices and protective devices. Before returning the product to service, observe all instructions on commissioning. (⇒ Section 6.1, Page 21)

2.8 Unauthorised modes of operation

- The valve is operated outside the limits stated in the operating manual.
- The valve is not operated in accordance with the intended use.



(⇒ Section 2.2, Page 8)

3 Transport/Storage/Disposal

3.1 Checking the condition upon delivery

1. On transfer of goods, check each packaging unit for damage.
2. In the event of in-transit damage, assess the exact damage, document it and notify KSB or the supplying dealer and the insurer about the damage in writing immediately.

3.2 Transport

	⚠ DANGER
	<p>The valve could slip out of the suspension arrangement Danger to life from falling parts!</p> <ul style="list-style-type: none"> ▷ Only transport the valve in the specified position. ▷ Observe the information on weights, centre of gravity and fastening points. ▷ Observe the applicable local accident prevention regulations. ▷ Use suitable, permitted lifting accessories, e.g. self-tightening lifting tongs.
	CAUTION
	<p>Improper transport Damage to the valve!</p> <ul style="list-style-type: none"> ▷ Protect the valve and components against external forces (e.g. impacts, blows, vibrations).

To transport the valve, suspend it from the lifting tackle as illustrated.

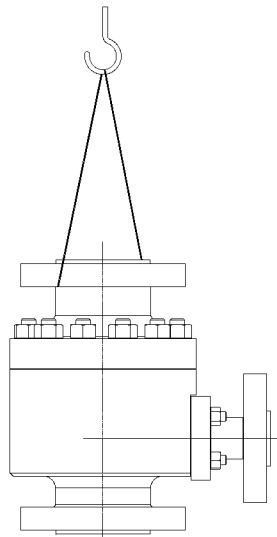



Fig. 1: Transporting the valve

1. Upon receipt, unpack the valve and check it for in-transit damage.
2. Report any in-transit damage to the manufacturer immediately.
3. Dispose of packaging material in accordance with local regulations.

3.3 Storage/preservation

If commissioning is to take place some time after delivery, we recommend that the following measures be taken for storing the valve:

	CAUTION
	<p>Damage due to frost, humidity or dirt Corrosion/contamination of the valve!</p> <ul style="list-style-type: none">▷ Store the valve in a dry, dust-free and vibration-free, frost-proof room where the atmospheric humidity is as constant as possible.▷ Protect the valve against contamination, e.g. with suitable caps or film.

Storage and/or temporary storage of the valves must ensure that even after a prolonged period of storage the valves' function is not impaired.

The temperature in the storage room must not exceed +40 °C.

For storing a valve which has already been operated, observe the measures to be taken for shutdown. (⇒ Section 6.3, Page 22)

3.4 Return to supplier

1. Drain the valve as described in the manual.
2. Flush and clean the valve, particularly if it has been used for handling noxious, explosive, hot or other hazardous fluids.
3. If the valve has handled fluids whose residues could lead to corrosion damage in the presence of atmospheric humidity or could ignite upon contact with oxygen also neutralise the valve and blow through with anhydrous inert gas to ensure drying.
4. When returning valves used for handling Fluids in Group 1 always complete and enclose a certificate of decontamination.
Indicate any safety measures and decontamination measures taken.

	NOTE
	If required, a blank certificate of decontamination can be downloaded from the following web site: www.ksb.com/certificate_of_decontamination

3.5 Disposal

	⚠ WARNING
	<p>Fluids handled, consumables and supplies which are hot or pose a health hazard Hazard to persons and the environment!</p> <ul style="list-style-type: none">▷ Collect and properly dispose of flushing fluid and any residues of the fluid handled.▷ Wear safety clothing and a protective mask if required.▷ Observe all legal regulations on the disposal of fluids posing a health hazard.

1. Dismantle the valve.
Collect greases and other lubricants during dismantling.
2. Separate and sort the valve materials, e.g. by:
 - Metals
 - Plastics
 - Electronic waste
 - Greases and other lubricants
3. Dispose of materials in accordance with local regulations or in another controlled manner.



4 Description of the Valve

4.1 General description

- Automatic recirculation valve

Process fluid controlled valve which automatically maintains the minimum flow rate required to ensure the operational reliability of the pump, protecting the centrifugal pump against overheating, loss of stability and cavitation. As soon as the main flow rate drops below a certain value, the valve opens its bypass wide enough for the minimum flow rate required by the pump to be recirculated, even when the main flow rate is zero at that time.

4.2 Product information

4.2.1 Product information as per Pressure Equipment Directive 2014/68/EU (PED)

The valves satisfy the safety requirements of Annex I of the European Pressure Equipment Directive 2014/68/EU (PED) for fluids in Groups 1 and 2.

4.2.2 Product information as per Regulation No. 1907/2006 (REACH)

For information as per European chemicals regulation (EC) No. 1907/2006 (REACH) see <https://www.ksb.com/en-global/company/corporate-responsibility/reach>.



4.3 Designation

Table 4: Designation example

Position								
1	2	3	4	5	6	7	8	9
9	0	-	-	-	-	-	-	-

Table 5: Designation key

Position	Code	Description
1-2	Type	
	90	Automatic recirculation valve
3	Design	
	1	Single-stage
	2	Two-stage
	3	Multistage
4	Size	
	2	1 1/2 inches
	3	2 inches
	4	2 1/2 inches
	5	3 inches
	6	4 inches
	7	5 inches
	8	6 inches
	9	8 inches
	A	10 inches
B	12 inches	
5	Pressure class	
	1	Class 150
	2	Class 300
	3	Class 600
	4	Class 900
	5	Class 1500
	6	Class 2500
	K	PN 40
	D	PN 64
	E	PN 100
	F	PN 160
	G	PN 250
H	PN 320	
J	PN 400	
6	Connection	
	F	Flanged ends
	W	Butt weld end
7	Installation position	
	V	Vertical
	H	Horizontal
8	Bypass option	
	S	Standard
	O	Oversized
	R	Reduced
9	Valve body material	
	C	Carbon steel

8546.8/01-EN



Position	Code	Description
9	S	Stainless steel
	A	Alloyed steel
	D	Duplex stainless steel

4.4 Marking

Table 6: General marking

Parameter	Values
Nominal size [inch]	NPS ...
Nominal pressure class	Class ...
Manufacturer	KSB
Type series/Model	MIL ...
Year of construction	20..
Material
Flow direction arrow	→
Traceability of the material
CE marking(if required and possible)	CE

In accordance with the current regulations and directives for pressure equipment the valves are marked as shown in the following table:

Fluids in Groups 1 and 2

Class	<1"	1 ¼"	1 ½"	2"	>2"
	25	32	40	50	>50
150					
>300					

Fig. 2: CE conformity marking: Fluids in Groups 1 and 2

Fluid groups In accordance with the current regulations and directives for pressure equipment, Group 1 comprises all fluids posing physical or health hazards, e.g. fluids defined as

- Explosive
- Extremely flammable
- Highly flammable
- Very toxic
- Toxic
- Oxidising

Fluid group 2 comprises all other fluids not referred to in Group 1.

4.5 Name plate

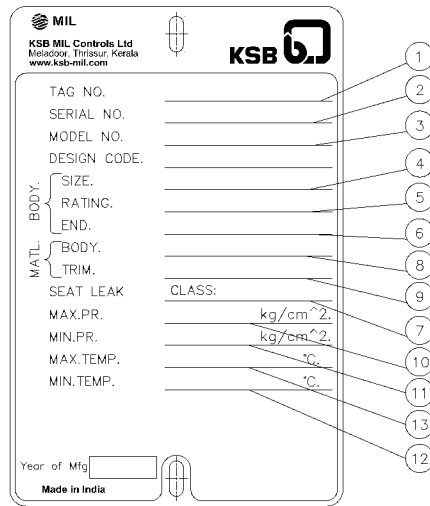

Fig. 3: Valve name plate (example)

1	TAG number	2	Serial number
3	Model number	4	Nominal size
5	Nominal pressure	6	Body end
7	Leakage class	8	Valve body material
9	Trim material	10	Maximum pressure [kg/cm ²]
11	Minimum pressure [kg/cm ²]	12	Minimum application temperature [°C]
13	Maximum application temperature [°C]		

4.6 Design details

Design

- Automatic Recirculation Valve to ASME B16.34
- Body made of forged steel
- Check valve function in main flow direction
- Integrated control valve in the bypass
- Hard-faced seat of lift check valve in the main flow direction
- Bypass with multistage throttling distance
- Leakage class IV in accordance with ANSI FCI 70.2: check valve in main flow direction (all designs)
- Leakage class IV in accordance with ANSI FCI 70.2: control valve in bypass (design 903/902)
- Flanged ends

4.7 Function

Design The valve has one inlet port and two outlet ports. The main outlet port connects to the main process and the bypass port connects back to the deaerator.

Function The main flow lifts the check disc (6). The check disc (6) changes its position depending on the flow rate of the pump and transfers this motion to the lever (9) of the bypass system. The motion of the lever (9) is transferred to the multistage bypass plug (19). In the bypass, the pressure and flow rate are reduced to the minimum flow conditions along a multistage throttling distance (low cavitation and low noise). As a result of modulating control, the sum of main flow rate and bypass flow rate is almost constant. The valve is flow-controlled and does not require an external control system or auxiliary energy.

High flow rate: The check disc (6) is fully open and the bypass system is fully closed.

Reduced flow rate: If the flow rate is reduced, the check disc (6) closes and the bypass system opens.

Low flow rate: If the flow rate drops below the pump's minimum flow value, the check disc (6) fully closes and the bypass system fully opens. The entire minimum flow rate is routed through the bypass system.

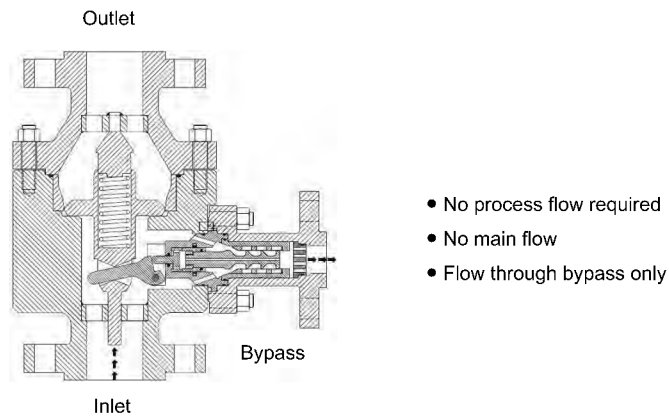

Fig. 4: Valve with closed check disc and open bypass

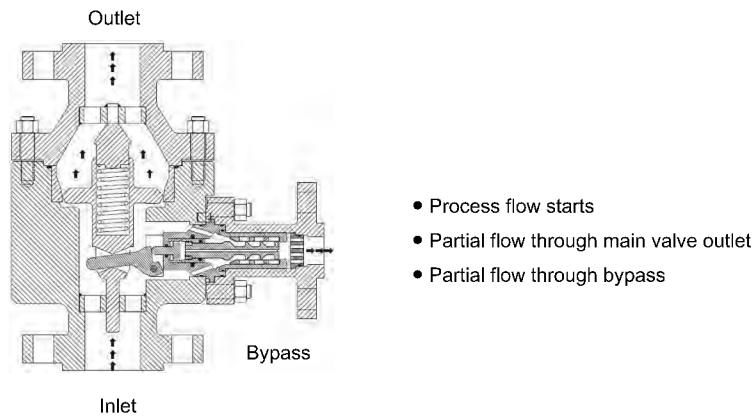
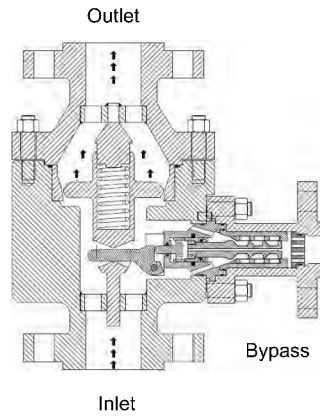
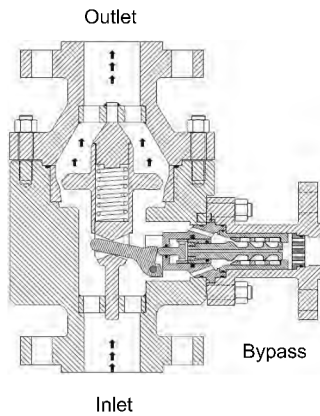

Fig. 5: Valve with open check disc and open bypass



- Check disc in half open
- Main flow is increasing
- No flow through bypass
- Switching point

Fig. 6: Valve with open check disc and closed bypass



- Increasing process flow required
- Main flow reaches maximum
- No flow through bypass

Fig. 7: Valve with open check disc at maximum travel and closed bypass

4.8 Scope of supply

4.9 Noise characteristic

When operated within the operating conditions documented in the order confirmation and/or characteristic curves booklets, the valve will not exceed a sound pressure level of 80 dB in acc. with IEC 60534-8-4. Unfavourable piping layouts or off-design operating conditions may give rise to physical phenomena like cavitation, resulting in significantly higher sound pressure levels.

5 Installation at Site

5.1 General information/Safety regulations

Responsibility for positioning and installing the valve lies with the consultant, the engineering contractor or the operator. Planning errors and installation errors can prevent the reliable function of the valves and pose a substantial safety hazard.

	<p>⚠ WARNING</p>
	<p>Damage to pressure enclosure or add-on parts Leakage from or rupture of the valve Valve/add-on parts not functional</p> <ul style="list-style-type: none"> ▸ Check the valve for in-transit damage prior to installation. ▸ Check any add-on parts for in-transit damage. ▸ Do not install damaged valves.

5.2 Installation position

The valve bodies are marked with an arrow indicating the flow direction.

Install the valves in such a way that the actual flow direction of the fluid matches the arrow on the valve body.

Install the valve in a vertical position with an upward flow direction. Deviations in installation position require prior consultation with KSB.

	<p>CAUTION</p>
	<p>Frequency shocks caused by pressure pulsation of the fluid handled Damage to the valve!</p> <ul style="list-style-type: none"> ▸ The distance between the pump discharge nozzle and valve connection flange must not exceed a straight pipe run of 3 m. ▸ A straight upstream stabilisation distance is essential.

Install the valve directly at the pump discharge nozzle. If it cannot be installed directly at the pump nozzle, it must be installed as close to the pump discharge nozzle as possible. The distance between the pump discharge nozzle and valve connection flange must not exceed a straight pipe run of 3 m. If the valve cannot be installed directly at the discharge nozzle, the valve requires a straight upstream stabilisation distance of at least 2x DN (no pipe bends).

To stabilise turbulent flows, a straight stabilisation distance of at least 3x DN is recommended downstream of the bypass port and of 1 m downstream of the valve outlet port. No pipe bends are permitted downstream of the bypass port.

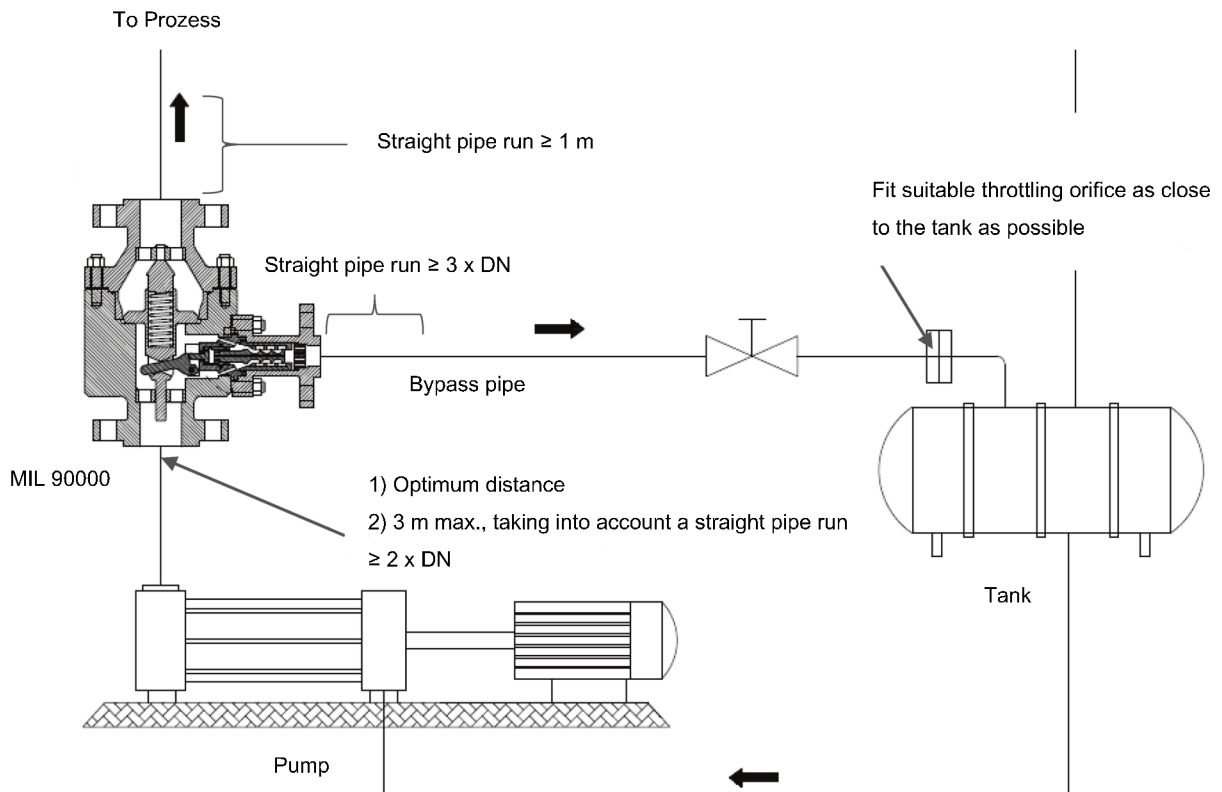

Fig. 8: Schematic diagram of the installation conditions

5.3 Preparing the valve

1. Thoroughly clean, flush and blow through all vessels, piping and connections.
2. Remove the valve's flange covers before installing it in the pipe.
3. Check that the inside of the valve is free from any foreign objects. Remove any foreign objects.
4. If required, install a strainer in the pipe upstream of the pump suction nozzle. Recommended mesh width: 0.3 mm to 0.5 mm.

5.4 Piping



5.4.1 Flange connection

- Fasteners** For the flange connection between the valve and piping and between the valve and pump, use the flange bolt holes provided.
- Flange connection**
- ✓ The mating flange faces are clean and undamaged.
 - ✓ Verify that the pipe is correctly aligned and the flanges are parallel.
1. Use an appropriate tool to evenly tighten the fasteners crosswise. (⇒ Section 7.3, Page 26)

6 Commissioning/Start-up/Shutdown

6.1 Commissioning/Start-up

6.1.1 Prerequisites for commissioning/start-up

	 DANGER
	<p>Risk of pressure surges / water hammer Danger to life caused by burns or scalds!</p> <ul style="list-style-type: none"> ▷ Do not exceed the valve's maximum permissible pressure. ▷ The operator shall provide general safety measures for the system.

Before commissioning/start-up of the valve ensure that the following requirements are met:

- The valve has been connected to the piping at both ends.
- The piping has been flushed.
- The material, pressure data and temperature data of the valve are compatible with the operating conditions of the piping. (⇒ Section 6.2, Page 21)
- The material's chemical resistance and stability under load have been checked.

6.1.2 Starting up the system

	NOTE
	<p>The system is commissioned at the same time as the pump is commissioned. When the pump starts, and with the gate valve in the main pipe closed, the specified minimum flow automatically flows through the valve bypass. The opening and closing action of the bypass can be checked by actuating the gate valve in the main pipe.</p>

- ✓ The manufacturer's product information for the pump is available.
 1. Start up the pump in accordance with the manufacturer's product literature.

6.2 Operating limits

6.2.1 Pressure/temperature ratings

Table 7: Permissible operating pressures [bar] (to ASME B16.34 Standard Class)

Class	Material	[°C]				
		-29 to +38	50	100	150	200
300	A105	51,1	50,1	46,6	45,1	43,8
600		102,1	100,2	93,2	90,2	87,6
900		153,2	150,4	139,8	135,2	131,4
1500		255,3	250,6	233	225,4	219



6.2.2 Ambient temperature

Observe the following parameters and values during operation:

Table 8: Permissible ambient temperatures

Ambient condition	Value
Ambient temperature	-10 °C to +60 °C
Humidity	5 % to 95 % rH

6.3 Shutdown





6.3.1 Measures to be taken for shutdown

During prolonged shutdown periods, ensure that the following conditions are met:

1. Drain fluids which change their physical condition due to changes in concentration, polymerisation, crystallisation, solidification, etc. from the piping.
2. If required, flush the piping with the valves fully opened.

7 Servicing/Maintenance

7.1 Safety regulations

	<div style="background-color: #e67e22; color: white; padding: 5px;">⚠ DANGER</div> <p>Valve under pressure Risk of injury! Leakage of hot and/or toxic fluids! Risk of burns!</p> <ul style="list-style-type: none"> ▷ Depressurise the valve and its surrounding system prior to any maintenance work and installation work. ▷ If there is fluid leakage, depressurise the valve. ▷ Allow the valve to cool down until the temperature of the fluid in all valve areas in contact with the fluid is lower than the fluid's vaporisation temperature. ▷ Never vent the valve by loosening the bolted/screwed connection between the upper body section and the lower body section. ▷ Use original spare parts and appropriate tools, even in emergencies.
	<div style="background-color: #f1c40f; color: white; padding: 5px;">⚠ WARNING</div> <p>Fluids handled, consumables and supplies which are hot and/or pose a health hazard Risk of injury!</p> <ul style="list-style-type: none"> ▷ Observe all relevant laws. ▷ When draining the fluid take appropriate measures to protect persons and the environment. ▷ Decontaminate valves used in fluids posing a health hazard.
	<div style="background-color: #2980b9; color: white; padding: 5px;">NOTE</div> <p>Before removing the valve from the piping, ensure that the pipe has been taken out of service and released for repair/maintenance work.</p>
	<div style="background-color: #2980b9; color: white; padding: 5px;">NOTE</div> <p>All maintenance work, service work and installation work can be carried out by KSB Service or authorised workshops. For contact details refer to the enclosed "Addresses" booklet or visit "https://www.ksb.com/en-global/contact" on the Internet.</p>

Never use force when dismantling and reassembling the valve.

7.2 Servicing/Inspection

7.2.1 Supervision of operation

Monitor the bypass:



If leakage occurs at the bypass more than the allowable leakage limit (with the lift check valve closed), this indicates that the seat or seat ring is damaged.

7.2.2 Inspection work

7.2.2.1 Checking the valve

- ✓ The valve has been dismantled.
 1. Check the valve disc, seat ring and body for cracks or damage.
 2. Check the control head and bush for damage.
 3. Clean all dismantled components and check them for signs of wear.
 4. If required, lap the valve disc and seat ring: The material loss for each component should be 0,5 mm.
 5. If required, replace any damaged or worn parts with original spare parts.
 6. If the control head and bush are damaged, replace the bypass trim.



7.2.2.2 Checking the sealing elements of the bypass system



	 WARNING
	<p>Defective sealing elements Valve malfunction</p> <ul style="list-style-type: none"> ▷ Replace the bypass trim. ▷ Replace the O-rings spare parts kit.

- ✓ Bypass has been dismantled.
 1. Replace bypass trim.
 2. Clean all dismantled components and check them for signs of wear.
 3. If required, lap the bypass plug and seat ring: The material loss for each component should be 0,2 mm.
 4. If required, replace any damaged or worn parts with original spare parts.

7.2.3 Dismantling the valve

7.2.3.1 General information/Safety regulations

	 WARNING
	<p>Hot surface Risk of injury!</p> <ul style="list-style-type: none"> ▷ Allow the valve to cool down to ambient temperature.

	 WARNING
	<p>Unqualified personnel performing work on the valve Risk of injury!</p> <ul style="list-style-type: none"> ▷ Always have repair work and maintenance work performed by specially trained, qualified personnel.

Always observe the safety instructions and information. (⇒ Section 7, Page 23)
In the event of damage you can always contact KSB Service.

7.2.3.2 Preparing for disassembly

1. Depressurise and drain the valve.
2. Switch off the pump and make sure it cannot be switched on again.
3. Shut off the piping upstream and downstream of the valve.



7.2.3.3 Removing the valve from the piping

- ✓ The valve has been depressurised and drained.
- ✓ The pump has been switched off and secured against being switched on again.
- ✓ The piping has been shut off upstream and downstream of the valve.
- ✓ The valve has cooled down to room temperature.
 1. Attach the valve to lifting gear but do not lift it up.
 2. Undo the bolts in the flange connection to the piping.
 3. Remove the valve from the piping.
 4. Safely store the valve.

7.2.3.4 Removing the bypass

- ✓ The valve has been removed from the piping.
 1. Remove the nuts (23) that connect the bypass body (25) to the lower body section (8).
 2. Remove the bypass body (25).
 3. Remove the perforated disc (33) from the bypass body (25).
 4. Position a screwdriver or mounting lever between the collar of the control head (30) and the lower body section (8).
 5. Carefully remove the bypass trim from the valve.
 6. Remove the assembly consisting of bypass plug (19), bush (26) and threaded ring (12) from the control head (30).
 7. Remove the balance bolt (29) from the control head (30).

7.2.3.5 Dismantling the lift check valve

	 WARNING
	Loaded spring Risk of injury! ▷ Before loosening the nuts, secure the upper body section using clamping elements.

- ✓ The bypass trim has been removed.
 1. Loosen and remove the nuts (3) on the upper body section (1).
 2. Remove the upper body section.
 3. Remove the spring from the valve disc (7).
 4. Remove the O-ring (4), spring (7), check disc (6) and liner (5).

7.2.4 Assembling the valve

7.2.4.1 Installing the lift check valve

- ✓ The spare parts required are available.
- ✓ All dismantled parts have been cleaned and checked for wear.
- ✓ Any damaged or worn parts have been replaced with original spare parts or re-lapped.
 1. Fit the liner (5) in the lower body section (8).
 2. Insert the check disc (6) in the lower body section (8). Make sure that the opening in the check disc shank (6) points in the direction of the bypass.
 3. Place the spring (7) in the check disc (6).
 4. Use grease to lubricate the O-ring (4) and place the O-ring (4) in the groove of the lower body section (8).

5. Fit the upper body section (1).
6. Tighten the nuts (3) crosswise to the specified tightening torque (⇒ Section 7.3, Page 26) .

7.2.4.2 Installing the bypass

	NOTE
Replace the entire bypass trim if the seat, check disc or sealing elements are damaged.	

- ✓ The spare parts required are available.
 - ✓ All dismantled parts have been cleaned and checked for wear.
 - ✓ Any damaged or worn parts have been replaced by original spare parts.
1. Insert new O-rings.
 2. Fit the pin (28) in the lower body section (8).
 3. Fit the balance bolt (29) in the control head (30).
 4. Fit the assembly consisting of bypass plug (19), bush (26) and threaded ring (12) in the control head (30).
 5. Insert the bypass trim into the bypass connection in the lower body section (8). Make sure that the lever (9) slides through the opening in the check disc shank (6).
 6. Make sure that the groove on the control head (30) aligns with the pin (28) in the lower body section (8).
 7. Install the perforated disc (22) in the bypass body (25).
 8. Connect the bypass body (25) with the lower body section (8) using nuts (23).
 9. Ensure that the pin (28) engages in the designated groove in the bypass body (25).
 10. Tighten the nuts (23) crosswise to the specified tightening torque (⇒ Section 7.3, Page 26) .

7.3 Tightening torques

Table 9: Tightening torques for bolts/screws

Thread size	Material	
	ASTM A193 Gr. B7	
	[lbf-ft]	[Nm]
M10 x 1,5	12	17
M12 x 1,5	22	30
M12 x 1,75	21	29
M14 x 2	34	46
M16 x 2	53	72
M18 x 2	78	105
M20 x 2	109	148
M20 x 2,5	104	140
M22 x 2,5	141	192
M24 x 1,5	204	276
M24 x 3	179	243
M27 x 3	263	356
M36 x 3	660	895





7.4 Returning to service

For returning the equipment to service, observe the sections on commissioning/start-up (⇒ Section 6.1, Page 21) and the operating limits (⇒ Section 6.2, Page 21) .

In addition, carry out all servicing/maintenance operations before returning the valve to service. (⇒ Section 7, Page 23)

8 Trouble-shooting

	 WARNING
	<p>Improper remedial work on the valve Risk of injury!</p> <p>▷ For any work performed in order to remedy faults on the valve observe the relevant information given in this operating manual and/or the product literature provided by the accessories manufacturers.</p>

If problems occur that are not described in the following table, consultation with the KSB service is required.

Table 10: Trouble-shooting

Problem	Possible cause	Remedy
No flow	Contaminated strainer	Clean or replace the strainer.
	Clogged piping	Flush the piping.
Little flow at the valve	Wear or damage to the valve or bypass unit	Replace the valve and/or bypass unit.
	Incorrect installation of the valve (against the direction of flow).	Install the valve in the direction of flow.
	Back pressure not maintained in the bypass line.	Increase the pressure in the tank or use appropriate back pressure valve.
Leakage at the seat	Check disc does not close completely.	<ul style="list-style-type: none"> ▪ Check the valve for corrosion or wear. ▪ Check for foreign objects in the seat area.
	Seat and/or check disc damaged.	<ul style="list-style-type: none"> ▪ Replace valve. ▪ Rework the sealing surfaces of the seat and check disc. ▪ Replace the check disc.
	Small back pressure at the bypass line.	Increase the pressure in the tank or use appropriate back pressure valve.
Leakage between the upper body section and lower body section	The sealing elements are not compressed sufficiently.	Check the tightening torque and re-tighten.
	Damaged sealing element	Replace the sealing element.
Leakage between the lower body section and the bypass body	The sealing elements are not compressed sufficiently.	The sealing elements are not compressed sufficiently.
	Damaged sealing element	Damaged sealing element
Leakage at the bypass	<ul style="list-style-type: none"> ▪ Foreign objects or contamination in the bypass. ▪ Defective internal parts or wear in the bypass. 	<ul style="list-style-type: none"> ▪ Check the bypass trim, clean if required. ▪ Replace bypass trim. ▪ Install additional strainers (mesh width 0.5 mm).
Surge pressure inside the valve	Cavitation in the bypass	Check the pressure at the bypass outlet, increase if required.
	Minimum flow rate of the pump is too low.	Contact the manufacturer.
	The strainer is contaminated.	Clean or replace the strainer.
	The system operating data does not match the data on the data sheet.	Correct the operating data and inform the manufacturer about the new operating data.
	Internal parts damaged	Check the valve, clean and/or replace the internal parts.



Problem	Possible cause	Remedy
Surge pressure inside the valve	Distance between the pump discharge nozzle and the valve connection flange > 3 m	Reduce the distance between the pump discharge nozzle and the valve connection flange to ≤ 3 m.
	Bend fitted in upstream stabilisation distance	Provide straight upstream stabilisation distance, avoid bends.
	Pump characteristic curve not stable	Check pump operation and stabilise the pump characteristic curve.
	Small back pressure at the bypass line	Increase the pressure in the tank or use appropriate back pressure valve.
Operational failure due to valve stuck up	<ul style="list-style-type: none">Foreign particles or contamination in the fluid entrapped in the moving components.Defective internal parts or wear in the bypass.Poor surface finish on the moving components due to foreign particle flow results in high friction in the sealing elements.	<ul style="list-style-type: none">Check the bypass trim, clean if required.Install additional strainers (mesh width 0.5 mm).Replace bypass trim.Inspect the components carefully and replace if required.

9 Related Documents

9.1 General assembly drawing with list of components

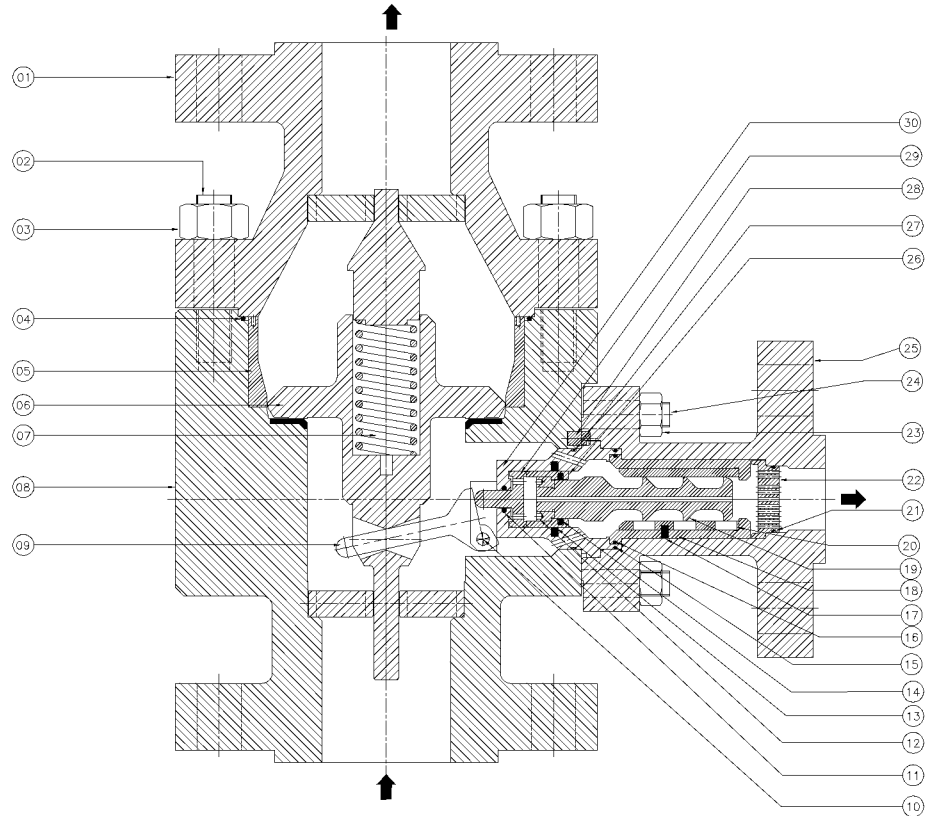

Fig. 9: Sectional drawing

Table 11: Parts list

i MOC as per above table is reference only. Other materials on request / application.

Part No.	Description	Material
1	Upper body section	ASTM A 105
2	Stud	ASTM A193 Gr. B7
3	Nut	ASTM A194 Gr. 2H
4 ¹⁾²⁾	O-ring	EPDM
5	Liner	SS 304
6	Check disc	SS 316L
7	Spring	SS 304
8	Lower body section	ASTM A 105
9 ³⁾	Lever	17-4 PH (H1150)
10 ³⁾	Pivot pin	AISI 420
11 ³⁾²⁾	Sealing element	PTFE + carbon/graphite
12 ³⁾	Threaded ring	AISI 420
13 ³⁾²⁾	Sealing element	PTFE + carbon/graphite
14 ³⁾²⁾	Sealing element	PTFE + carbon/graphite
15 ¹⁾²⁾	O-ring	EPDM

¹ Recommended spare parts

² Other material based on application/temperature.

³ Recommended spare parts (included in bypass trim spare parts kit)



Part No.	Description	Material
16 ¹⁾²⁾	O-ring	EPDM
17 ³⁾	Spring-type straight pin	AISI 420
18 ³⁾	Seat	AISI 420
19 ³⁾	Bypass plug	AISI 420
20 ³⁾	Liner	AISI 420
21 ¹⁾²⁾	O-ring	EPDM
22	Perforated disc	AISI 420
23	Nut	ASTM A194 Gr. 2H
24	Stud	ASTM A193 Gr. B7
25	Bypass body	ASTM A 105
26 ³⁾	Bush	AISI 420
27 ¹⁾²⁾	O-ring	EPDM
28	Pin	SS 316
29 ³⁾	Balance bolt	AISI 420
30 ³⁾	Control head	AISI 420

8546.8/01-EN

9.2 Dimensions and weights

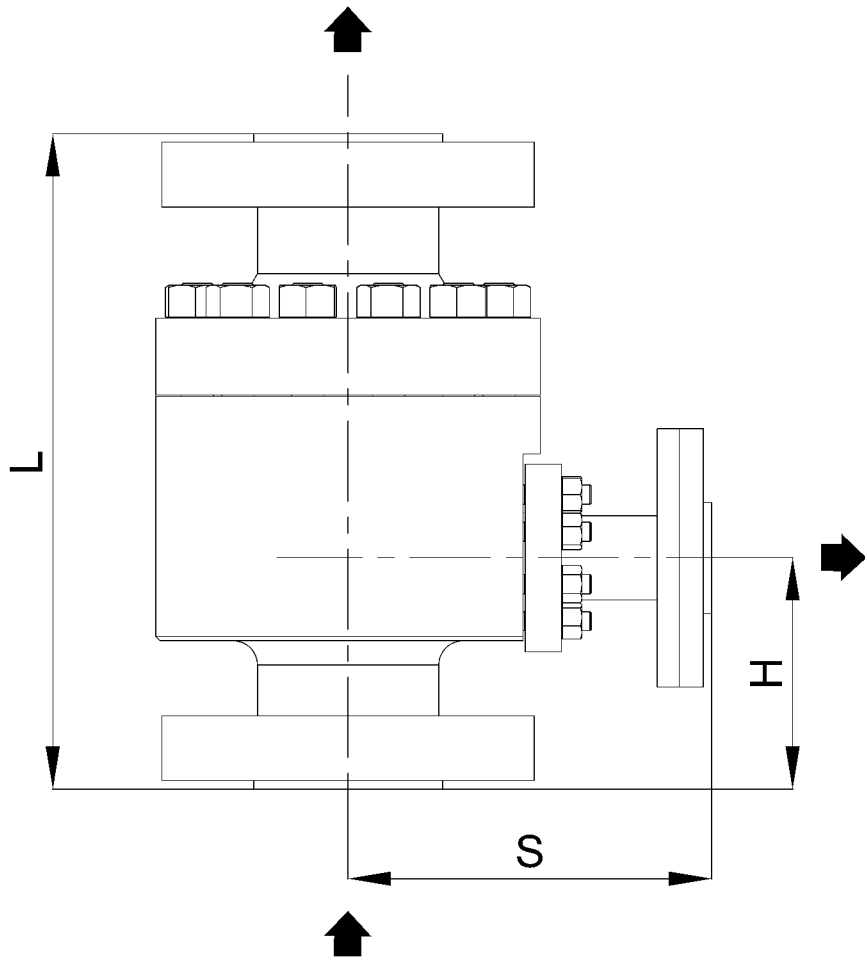

Fig. 10: Sectional drawing of MIL 90000

Table 12: Dimensions and weights

Type	Main body		Bypass body		Class	L [mm]	S [mm]	H [mm]	[kg]
	NPS	DN	NPS	DN					
	[inch]	[mm]	[inch]	[mm]					
90322	1,5	40	1	25	300	260	190	90	31
90323	1,5	40	1	25	600	260	190	90	34
90324	1,5	40	1	25	900	300	200	110	36
90325	1,5	40	1	25	1500	310	215	120	49
90332	2	50	1	25	300	300	185	115	45
90333	2	50	1	25	600	300	193	110	48
90334	2	50	1	25	900	340	203	130	70
90335	2	50	1	25	1500	350	233	130	80
90342	2,5	65	1,5	40	300	340	199	125	65
90343	2,5	65	1,5	40	600	340	220	125	70
90344	2,5	65	1,5	40	900	380	230	140	96
90345	2,5	65	1,5	40	1500	400	250	145	112
90352	3	80	1,5	40	300	380	233	140	85
90353	3	80	1,5	40	600	380	240	140	96
90354	3	80	1,5	40	900	410	250	150	115
90355	3	80	1,5	40	1500	450	275	165	149



Type	Main body		Bypass body		Class	L [mm]	S [mm]	H [mm]	[kg]
	NPS	DN	NPS	DN					
	[inch]	[mm]	[inch]	[mm]					
90362	4	100	2	50	300	430	266	155	125
90363	4	100	2	50	600	430	266	155	176
90364	4	100	2	50	900	450	280	160	188
90365	4	100	2	50	1500	520	300	190	249
90372	5	125	2	50	300	500	290	175	183
90373	5	125	2	50	600	500	300	175	235
90374	5	125	2	50	900	525	310	185	273
90385	5	125	2	50	1500	650	341	235	338
90382	6	150	2,5	65	300	550	350	190	257
90383	6	150	2,5	65	600	585	355	190	273
90384	6	150	2,5	65	900	785	355	200	455
90385	6	150	2,5	65	1500	700	405	250	547
90392	8	200	3	80	300	650	405	215	470
90393	8	200	3	80	600	680	430	225	555
90394	8	200	3	80	900	700	430	225	558
90395	8	200	3	80	1500	880	485	310	938

Mating dimensions as per standard

Flanges:

ASME B16.5

Flanges:

DIN EN 1092-1



10 EU Declaration of Conformity for MIL 90000

Automatic recirculation valve

MIL 90000

Class 150 - 2500

NPS 1 - 12 inches

satisfies the safety requirements laid down in the European Pressure Equipment Directive 2014/68/EU.

Other standards/codes:

EN 12516-1 / EN 12516-2, ASME B16.34

Suitable for:

Fluids in Groups 1 and 2

Conformity assessment procedure:

Module H

Name and address of the notified body responsible for approval and surveillance:

TÜV NORD Systems GmbH & Co. KG
22525 Hamburg (Germany)

Identification number of the notified body:

0045



Index

C

CE marking 15
Certificate of Decontamination 35
Commissioning/start-up 21

D

Design 16
Designation 14
Dismantling 24
Disposal 12

E

Event of damage 6

F

Faults
 Causes and remedies 28
Flange connection 20
Fluids in Group 1 15
Fluids in Group 2 15
Function 17

I

Intended use 8

K

Key to safety symbols/markings 6

M

Maintenance 23
Marking 15
Materials 30

N

Name plate 16
Noise characteristic 18

O

Operating limits 8, 22
Other applicable documents 6

R

Return to supplier 12
Returning to service 27

S

Safety awareness 9
Shutdown 22

T

Transport 11

W

Warnings 6
Warranty claims 6