

Model RB-24E
Conductance Type
Low Water Cut-Off
 For Residential 24 VAC Hot Water Boilers

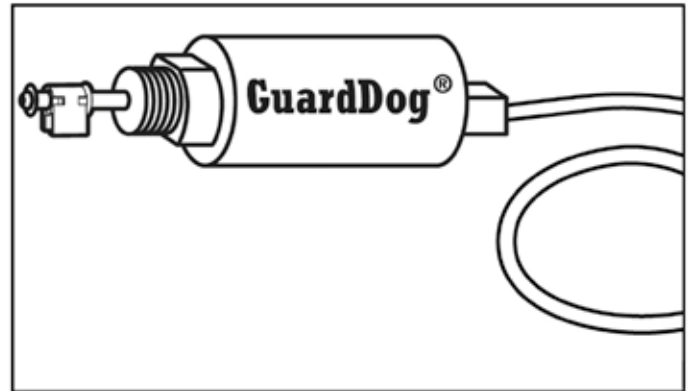

⚠ WARNING

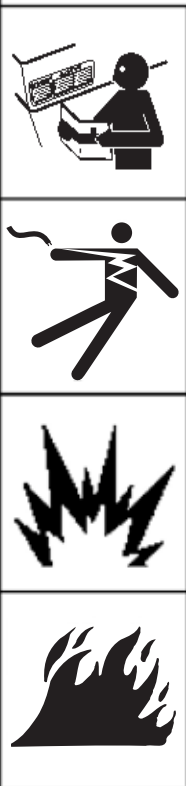

- Before using this product read and understand instructions.
- Save these instructions for future reference.
- All work must be performed by qualified personnel trained in the proper application, installation, and maintenance of plumbing, steam, hot water, and electrical equipment and/or systems in accordance with all applicable codes and ordinances.
- To prevent electrical shock, turn off the electrical power before making electrical connections.
- This low water cut-off must be installed in series with all other limit and operating controls installed on the boiler. After installation, check for proper operation of all of the limit and operating controls, before leaving the site.
- We recommend that secondary (redundant) Low Water Cut-Off controls be installed on all steam boilers with heat input greater than 400,000 BTU/hour or operating above 15 psi of steam pressure. At least two controls should be connected in series with the burner control circuit to provide safety redundancy protection should the boiler experience a low water condition. Moreover, at each annual outage, the low water cut-offs should be dismantled, inspected, cleaned, and checked for proper calibration and performance.
- This product can expose you to chemicals including Lead, which is known to the State of California to cause cancer and birth defects or other reproductive harm. For more information go to: www.P65Warnings.ca.gov.

Failure to follow this warning could cause property damage, personal injury or death.

OPERATION

The Model RB-24E Low Water Cut-Off is specifically designed to provide burner cut-off if there is an unsafe water loss, which can result from a broken or leaking radiator or pipe, or a cracked section in the boiler.

Water/glycol mixtures up to 50% concentration may be used.

SPECIFICATIONS

Temperature:

Storage: -40°F to 120°F (-40°C to 49°C)

Ambient: 32°F to 120°F (0°C to 49°C)

Humidity: 85% (non-condensing)

Maximum Water Pressure: 160 psi (11.2 kg/cm²)

Maximum Water Temperature: 250°F (121°C)

Electrical Ratings

Voltage	Power Consumption	Switching Capacity
24 VAC	2.5 VA	2A at 24 VAC

Enclosure Rating: NEMA 1 General Purpose

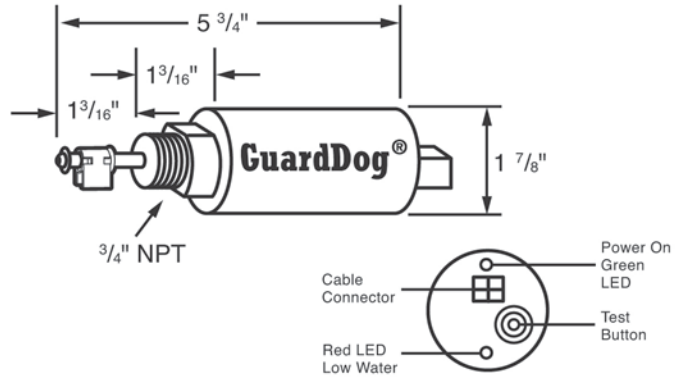

IMPORTANT: Do not use Model RB-24 on steam boilers.

IMPORTANT: Do not use on millivolt systems.

IMPORTANT: Before making any wiring connections to the boiler with the connector or 'Y' harnesses, You **MUST** wire the boiler per boiler manufacturer's recommendations and verify operation.

IMPORTANT: Universal wiring harness adaptors are now available for use with systems having modular plug-on burner controllers and vent dampers (sold separately).

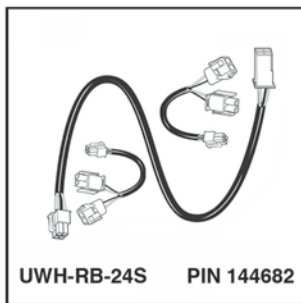
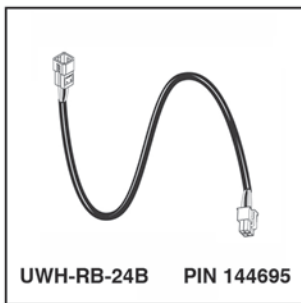

The **UWH-RB-24B** is for use on hot water boilers that have a harness plug connection.

The **UWH-RB-24A** is for use on hot water boilers that have a vent damper.

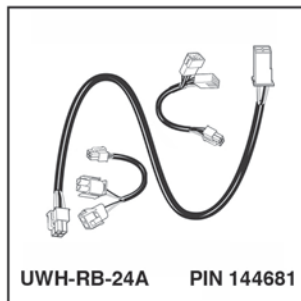
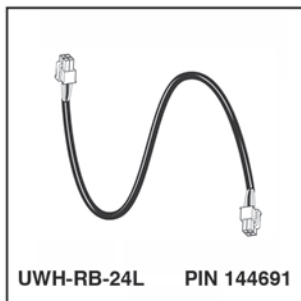

The **UWH-RB-24S** is for use on hot water boilers that have a transformer plug connection on the aquastat.

The **UWH-RB-24L** is for use on hot water boilers that have a control panel connection.



INSTALLATION –

TOOLS NEEDED:

Pipe wrench or channel lock pliers.

STEP 1 - Determine Where to Install the Low Water Cut-Off

Determine where to install the probe control based on the following requirements:

- If tapings are provided on the boiler, install the probe control in one that is above the minimum safe water level, as specified by the boiler manufacturer. If no specified minimum safe water level is designated, contact the boiler manufacturer.
- If no tapping is provided on the boiler, install the probe control in a header or riser pipe above the boiler. Refer to the Typical Installation Diagrams below.

TYPICAL INSTALLATIONS

On the Boiler (RECOMMENDED)

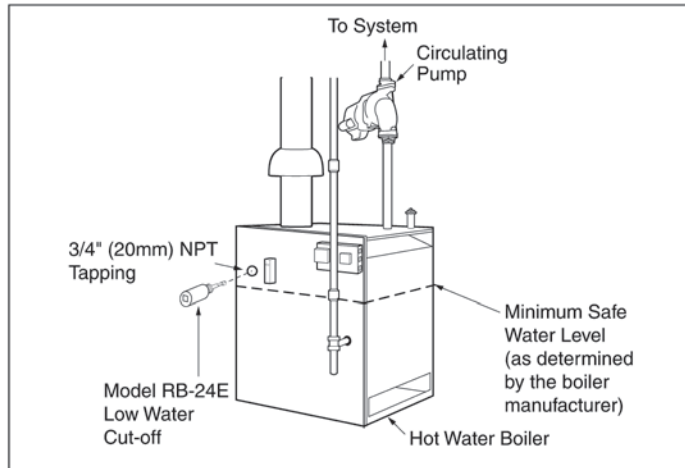

In a Pipe Tee Above the Boiler

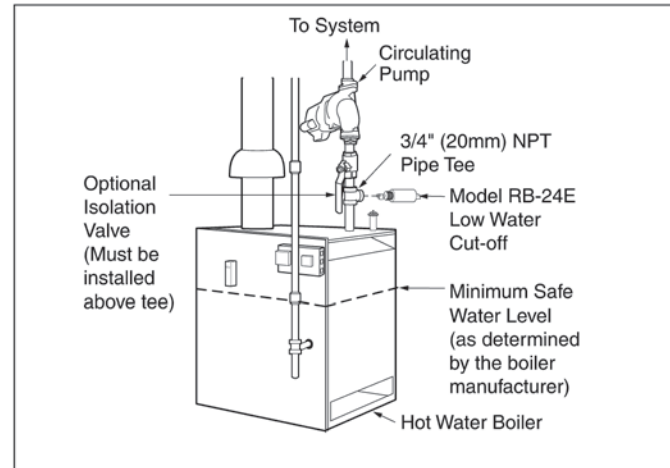

For all Applications:

- Make sure probe is installed above minimum safe water line as determined by the boiler manufacturer.
- Make sure that ends and sides of the probe are at least 1/4" (6.4mm) from all internal metal surfaces.

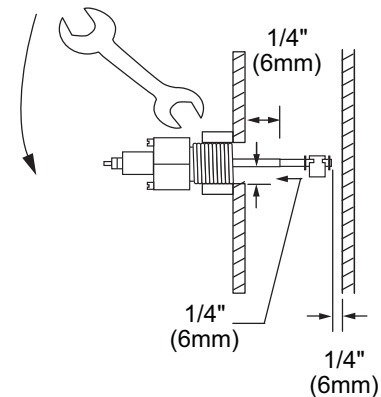



Option 3

Certain types of boilers may utilize a relay or series of relays to control the burner and circulator circuits. To wire into a boiler of this type, the Model RB-24E can be wired as shown.

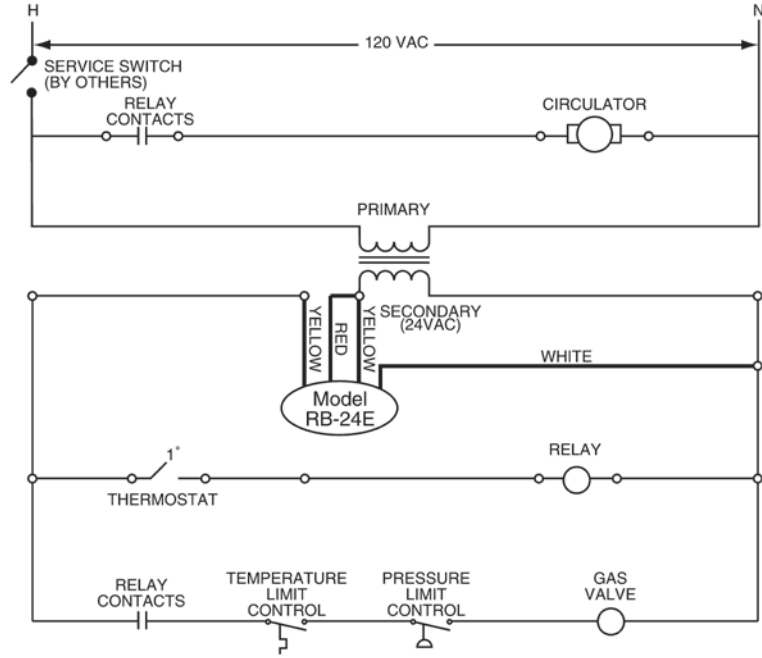

Option 4

Some boiler wiring diagrams indicate where a LWCO should be wired. In this diagram the RB-24E can be wired as shown.

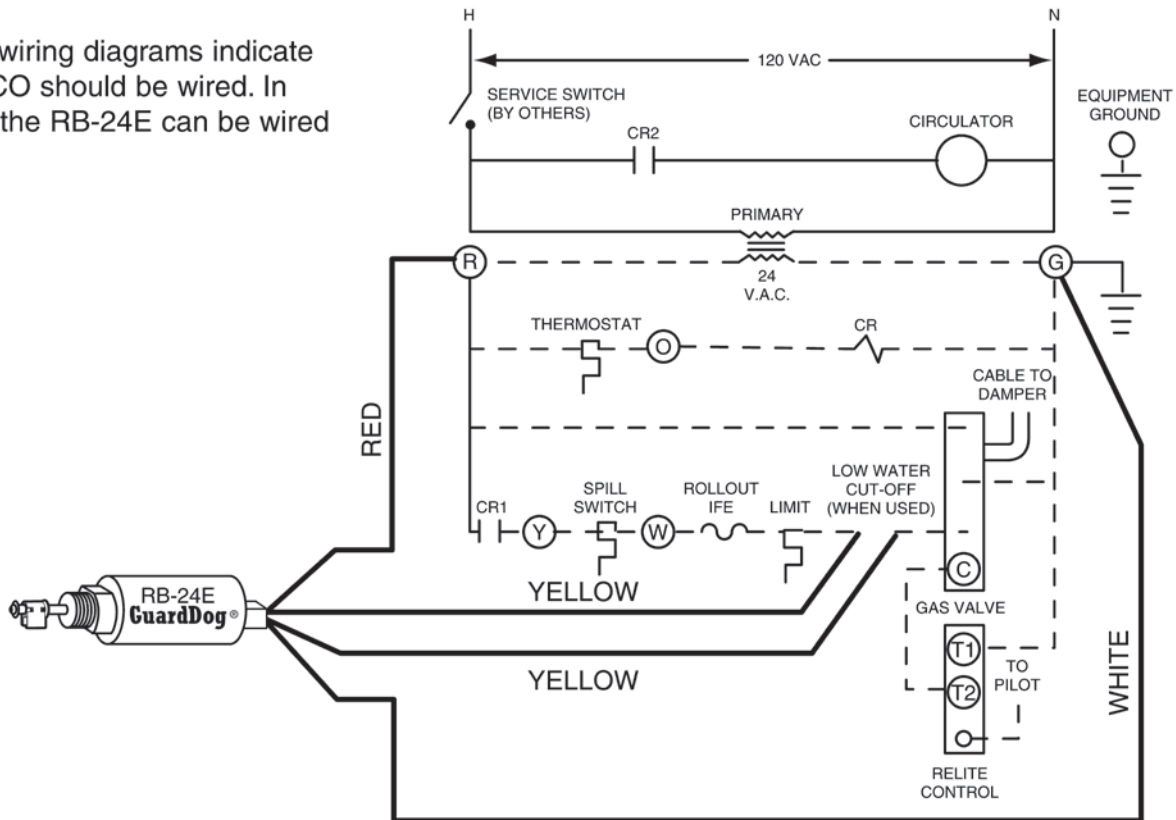

\\nt_server\master\rsi_jobs\16216_Xylem\pdfs\MM228_REV_K005.pdf Page 5 Author: Rampage Systems, Inc. ExtractPage Creator: Rampage JDF Imposition Producer: pdfLib Personalization Server 7.0.4 (C++/Win32) 2438.0 dpi (Screened Data File POS, Right-Reading, Color-Seps, Std-OVP) [Scaling Percent: HT 100 % \rsi\lut\C:200815 M:200875 Y:20080 K:200845] bleed: 0.125 margin size: 0.375 ID: WS2:

STEP 3 - Installing the Low Water Cut-Off

- a. **Sparingly**, apply pipe sealant to the external threads (D) of the probe (A).

WARNING

Do not use PTFE tape. Only use pipe sealant. Failure to follow these instructions will cause the probe not to function as intended and could cause property damage, personal injury or death.

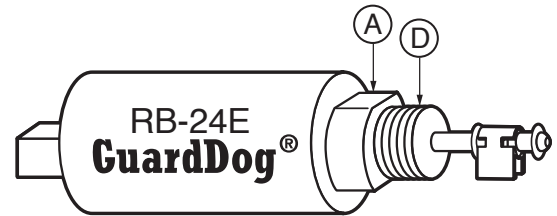

- b. Insert the probe portion (B) of the low water cut-off into the $\frac{3}{4}$ " (20mm) NPT tapping (C) on the boiler **OR** into a $\frac{3}{4}$ " (20mm) NPT pipe or reducing tee (D) above the boiler. Do not cross thread the low water cut-off.

Fully **hand tighten** the low water cut-off (approximately 4 revolutions) to approximately 6 ft•lb (8 N•m).

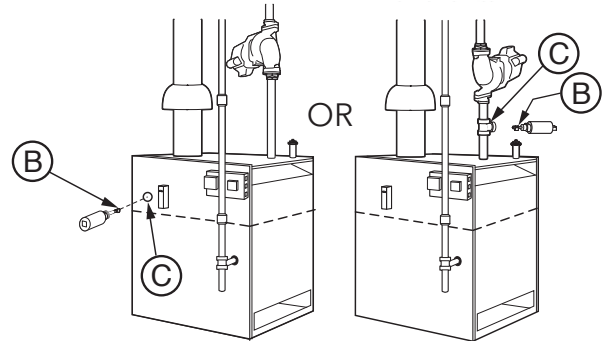

- c. Using a wrench, tighten the unit (A) into the tapped connection (E) that was determined in Step 1 of these instructions. Tighten to 47 ft•lb (64 N•m).

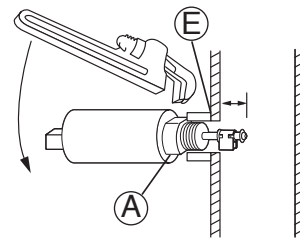

- d. Install the plug end of the cable (E) into the low water cut-off (F).

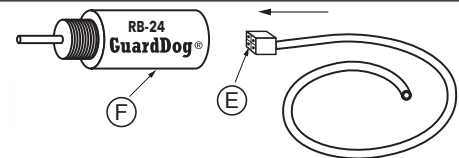

STEP 4 - Testing

- a. **Before filling the system**, turn on the electric power to the boiler. The low water cut-off's green "Power On" LED should be illuminated. With the room thermostat set on "heat," confirm that the burner **will not** operate without water in the system. The low water cut-off's red LED should be illuminated.

NOTE: The burner will come on briefly (1 second or less) and then shut off to verify proper operation.

- b. Fill the system with water. When water is just above the probe, the low water cut-off's red LED should turn off.
- c. Check and confirm that the boiler's thermostat, burner and safety limits are operating properly after filling system and before leaving the site.
- d. Check the threaded connection of the low water cut-off for leakage. Tighten, if necessary.

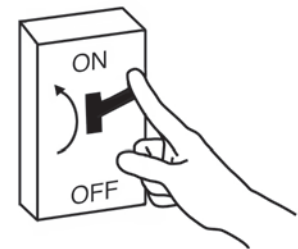

Testing Control Using “Test Button”

Pressing the “Test Button” interrupts the probe circuit which simulates water off the probe.

- a. Press and hold “test button” while burner is running.
- b. The burner should turn OFF and red light turn ON if burner is wired correctly.
- c. Release the test button and the red light should turn off and the boiler should turn on provided that the boiler water in contact with the probe.

INSTALLATION COMPLETE

TROUBLESHOOTING:

If control fails to operate, perform the following diagnostic checks.

1. Check to be sure that the water level in the boiler is at or above the level of the probe.
2. Re-check all wiring to ensure proper connections as specified in boiler manufacturers wiring diagrams.
3. Check to ensure that PTFE tape has not been used on the threaded connection of the probe to the boiler.
4. Check the quality of the boiler water to ensure adequate conductance.

Boiler Does Not Turn Off (when water is below probe)

- Turn off boiler and check boiler wiring connections.
- Turn off boiler, drain boiler and remove control to check if the tip of the probe is touching a metal surface.

Boiler Does Not Turn ON

- Make sure water is above the level of the probe.
- Make sure probe is installed in a location where an air pocket cannot develop.
- Check boiler wiring connections.

Boiler Does Not Turn ON and RB-24E Red LED blinking

- Problem is wrong transformer ‘Y’ harness.
- Turn off boiler and install correct transformer ‘Y’ harness.

MAINTENANCE

SCHEDULE:

- Test the low water cut-off annually or more frequently.
- Remove and inspect the self-cleaning probe every 5 years.
- Replace the low water cut-off every 15 years.

NOTE

Clean probe by wiping with non-abrasive cloth and rinsing with clean water. DO NOT use sharp instruments to remove any accumulations of rust or scale.



CAUTION

Replace Probe if:

- PTFE insulator is cracked or worn.
- Probe is loose.

Failure to follow this caution could cause property damage, personal injury or death.