



## Operating instructions Heater GP 70



### Contents

<b>Heater GP 70</b> .....	<b>1</b>
<b>Contents</b> .....	<b>1</b>
<b>Safety</b> .....	<b>1</b>
<b>Checking the usage</b> .....	<b>2</b>
Type code .....	2
Part designations .....	2
Type label .....	2
<b>Installation</b> .....	<b>2</b>
<b>Tightness test</b> .....	<b>3</b>
<b>Removing the protective caps (optional)</b> .....	<b>3</b>
<b>Wiring</b> .....	<b>3</b>
Connecting the room thermostat for "Heating" and "Controlled air flow" mode .....	4
Connecting multiple heaters to a single room thermostat .....	5
Reset, alarm, external fan .....	5
Adjusting the switch-on delay $t_E$ .....	5
<b>Commissioning</b> .....	<b>6</b>
<b>Adjusting the heater</b> .....	<b>6</b>
<b>Installing the protective caps</b> .....	<b>7</b>
<b>Cleaning</b> .....	<b>8</b>
<b>Assistance in the event of malfunction</b> .....	<b>9</b>
<b>Maintenance</b> .....	<b>12</b>
<b>Checking the safety functions and burner operation</b> .....	<b>14</b>
<b>Accessories</b> .....	<b>14</b>
<b>Spare parts</b> .....	<b>16</b>
<b>Technical data</b> .....	<b>17</b>
<b>Declaration of conformity</b> .....	<b>17</b>
<b>Goods return form</b> .....	<b>18</b>
<b>Contact</b> .....	<b>18</b>

## Safety

### Please read and keep in a safe place



Please read through these instructions carefully before installing or operating. Following the installation, pass the instructions on to the operator. This unit must be installed and commissioned in accordance with the regulations and standards in force. These instructions can also be found at [www.docuthek.com](http://www.docuthek.com).

### Explanation of symbols

■, **1**, **2**, **3**... = Action  
> = Instruction

### Liability

We will not be held liable for damage resulting from non-observance of the instructions and non-compliant use.

### Safety instructions

Information that is relevant for safety is indicated in the instructions as follows:

#### **⚠ DANGER**

Indicates potentially fatal situations.

#### **⚠ WARNING**

Indicates possible danger to life and limb.

#### **! CAUTION**

Indicates possible material damage.

All interventions may only be carried out by qualified gas technicians. Electrical interventions may only be carried out by qualified electricians.

Persons under the age of 18 as well as persons with reduced physical, sensory or mental capabilities or lack of experience and knowledge are not allowed to use, clean or service this device. Staying near the device or its use is prohibited, even if said persons are supervised or have been instructed on the safe use of the devices and are aware of the resulting dangers.

### Conversion, spare parts

All technical changes are prohibited. Only use OEM spare parts.

### Changes to edition 06.13

The following chapters have been changed:

- Spare parts
- Technical data

## Checking the usage

### GP 70

Heater with direct, open combustion for agricultural stables and horticultural greenhouses. Depending on the type and setting, the heater can be operated with natural gas or LPG (propane/butane).

This function is only guaranteed when used within the specified limits – see page 17 (Technical data). Any other use is considered as non-compliant.

### Type code

Code	Description
<b>GP</b>	Heater
<b>70</b>	Capacity 70 kW, jet length 50 m

### Part designations

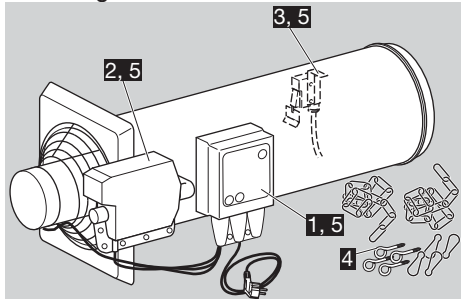

- 1 Burner control unit BCU
- 2 Gas combination control CG
- 3 Vane
- 4 Assembly accessories
- 5 Protective cap set for use in agriculture (option)

### Type label

Air circulation, electrical connection rating, voltage, rated heat input, gas type, category, supply pressure, burner pressure, enclosure: see type label.

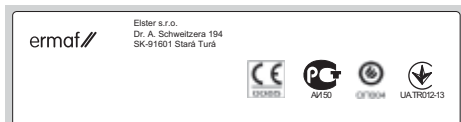

- Before installation, check whether the device is suitable for the regional gas type and the specified limits, see type code and page 17 (Technical data).

## Installation

### ⚠ DANGER

Danger of death! Gases are generated during the storage of slurry which remain partly dissolved in the liquid. If the slurry is strongly agitated during mixing and purging, poisonous, explosive gases such as hydrogen sulphide and methane are released. If an ignition source is present, the released gas can explode.

To avoid damage during operation, please observe the following:

- Switch off the heater before mixing and purging the slurry.
- Close the slide valves when storing slurry outside.
- The fan for the air supply must not be part of a closed pipe system.
- The space to be heated must be adequately ventilated.
- For mechanical extraction equipment: at least 10 m<sup>3</sup>/h of air per installed capacity.
- In the case of natural ventilation, the structure must have two apertures with a free opening area of 60 x B in cm<sup>2</sup>. "B" is the installed capacity in kW. Replacement of the full air volume per hour is thus ensured.
- In the case of natural ventilation, the maximum allowable total capacity of the heater is 1 kW per 20 m<sup>3</sup> of volume.
- Respect the safety distance of the heater to inflammable materials, see "Installation position".
- Consult your fire insurance provider and/or local fire protection engineer to assess the foreseeable, general risk of fire.
- For cleaning, care and maintenance, note the applicable national regulations and directives.
- No condensation permitted. Check the ambient temperature, see page 17 (Technical data).

### Installation position

- ▷ To ensure that the vane functions faultlessly, install the unit in the horizontal position.
- ▷ Note the safety distance to walls and inflammable materials.

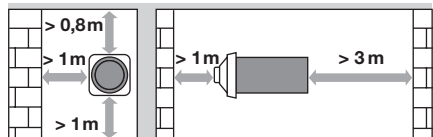

- ▷ Ensure sufficient free space around the device. There must be no obstructions in front of the inlet and outlet side of the heater.
- ▷ To avoid overheating, do not cover the electric motor.

## Connecting the gas supply

- ▷ If the heater is suspended on chains, use an approved flexible gas hose.
- 1** Disconnect the system from the electrical power supply.
- 2** Shut off the gas supply.
- 3** Remove the sealing plug at the inlet tube of the gas combination control CG.
- 4** Connect the gas pipe with threaded connection (Rp 3/4" internal thread) or gas hose, see page 14 (Accessories), to the inlet tube of the gas combination control.
- ▷ Use approved sealing material only.
- ▷ Note the maximum inlet pressure, see page 17 (Technical data).

## Tightness test

- ▷ The system is disconnected from the electrical power supply. The valves are thus closed.

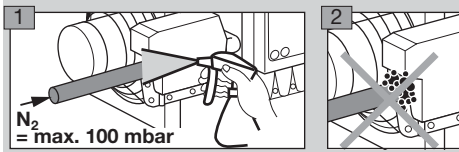

## Removing the protective caps (optional)

- ▷ For agricultural use, the burner control unit, gas combination control and vane switch are mostly protected against ingress of dirt and moisture by a cap.
- ▷ To wire the burner control unit and to start and adjust the heater, the protective caps are to be removed as described below.
- ▷ Do not remove the protective cap on the vane switch.

### Burner control unit

- 1** Slowly pull apart the ends of the protective cap on the back of the burner control unit until the rivets come undone.

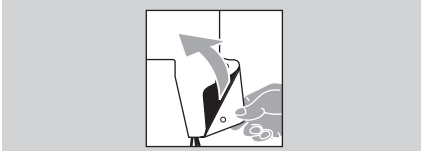

- 2** Pull the opened edges of the protective cap fully so that the edges are pulled out from between the burner control unit and the mounting plate.

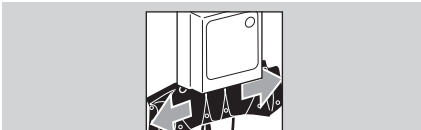

- 3** Remove the opened protective cap from the burner control unit by pulling it upwards.



### Gas combination control

- 1** Slowly pull apart the ends of the protective cap on the underside until all the rivets come undone.

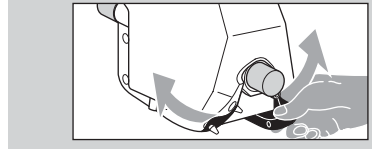

- 2** Starting on the right-hand side, pull the opened protective cap upwards over the gas outlet.

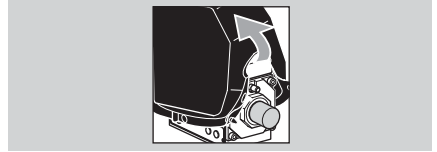

- 3** Remove the protective cap completely by pulling over the left-hand side of the gas inlet.

## Wiring

### ! CAUTION

Danger of electric shocks!

- Before working on possible live components, ensure the unit is disconnected from the power supply.

- 1** Disconnect the system from the electrical power supply. The mains plug may only be pulled out once the device has been switched off.

- 2** Shut off the gas supply.

- ▷ If there is a protective cap on the burner control unit, this must first be removed.
- ▷ When opening the burner control unit, do not incline the upper housing section during its removal to prevent the plug connectors from being bent.

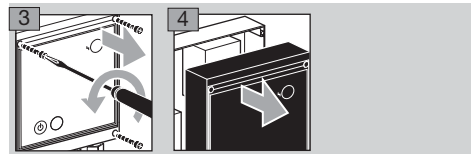

# Burner control unit BCU connection diagram

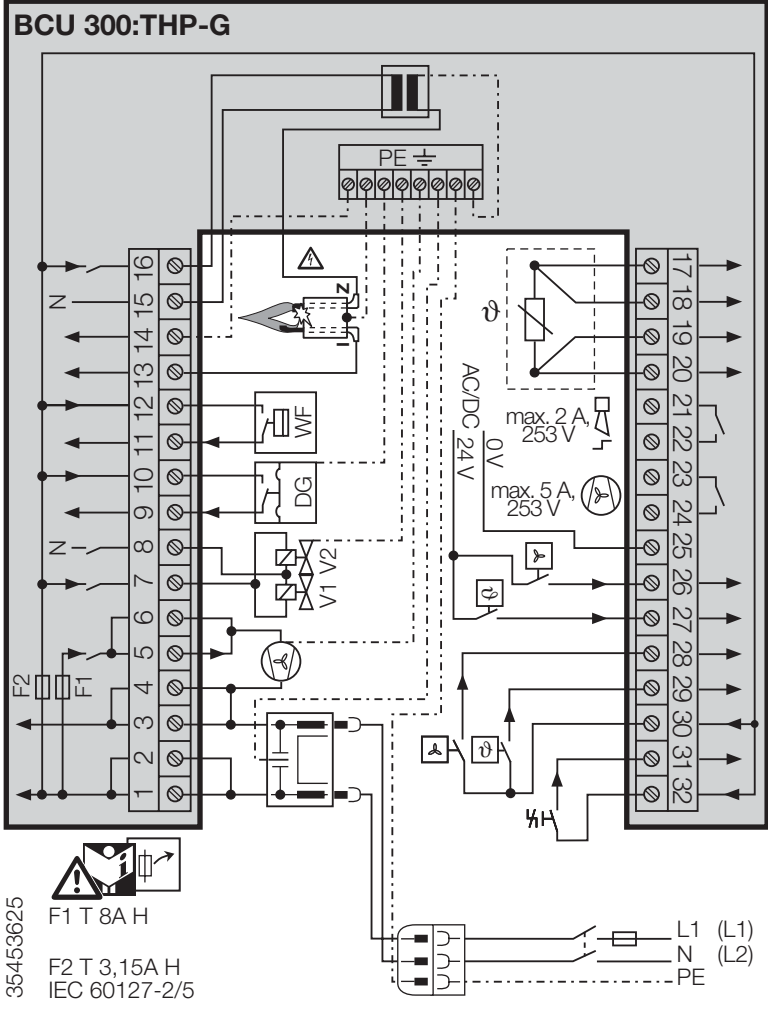

- ▷ In order to ensure post-cooling, the heater constantly requires 230 V AC.

### Connecting the room thermostat for "Heating" and "Controlled air flow" mode

- ▷ Use a room thermostat with a hysteresis of  $\pm 1^\circ\text{C}$ . It switches on if the room temperature is  $1^\circ\text{C}$  less than the set temperature and switches off again once the room temperature is  $1^\circ\text{C}$  more than the set temperature.
- ▷ Do not directly connect the room thermostat to terminals 1 and 3.

- 5** Connect the terminals for Controlled air flow and Heating .

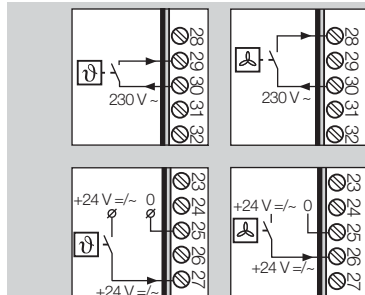

## Connecting multiple heaters to a single room thermostat

- ▷ Phase reversal will result in a short-circuit.
- ▷ Do not install different phases of a three-phase current system at the inputs if the voltage between the phases exceeds 230 V (+ 10%).
- ▷ Multiple heaters must be wired to the thermostat via a relay.

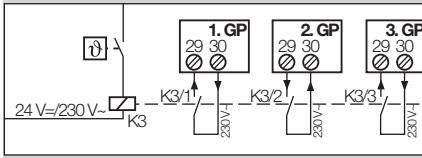

- ▷ At 24 V DC/AC, multiple heaters can be controlled in parallel.
- ▷ Note the polarity!

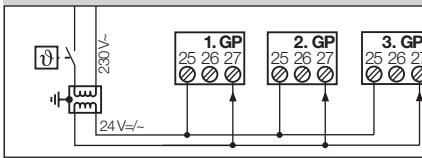

- ▷ Do not directly connect the thermostat to multiple heaters.
- ▷ Do not connect terminals 28, 29 and 30 directly to the next heater. A short-circuit can occur due to different phases and polarities.

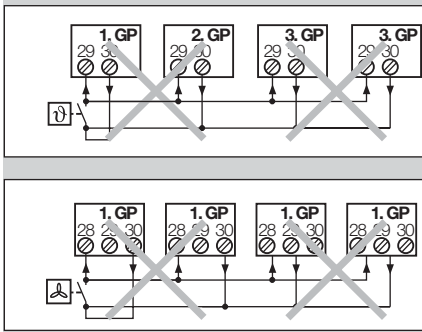

## Reset, alarm, external fan

- ▷ For external fault signalling, an external alarm and an external reset button can be connected.

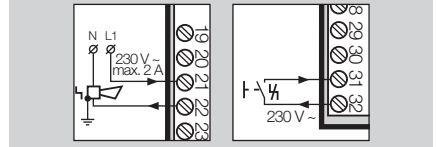

- 6 For improved air circulation in the room, an additional fan can be connected.

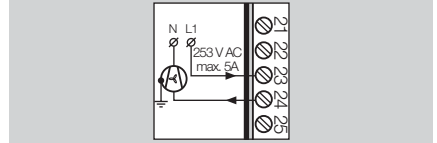

- ▷ In case of a power failure, an emergency power supply unit should automatically take over the power supply. Emergency power supply units with a cardan shaft drive for tractor attachment are also suitable.

## Adjusting the switch-on delay $t_E$

- ▷ If multiple heaters switch on at the same time, there can be a gas and/or power shortage on individual devices. To avoid this happening, adjust the switch-on delay  $t_E$  using the potentiometer in the upper housing section of burner control unit BCU.
- ▷ The potentiometer is set to 0 s at the factory.

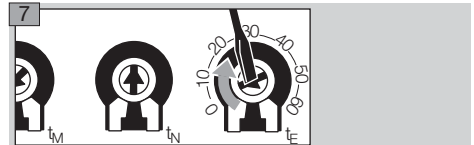

- ▷ We recommend using a switch-on delay  $t_E$  of 5 to 10 s between each device.
- ▷ The post-cooling time  $t_N$  is set to 50 s at the factory and the minimum burner on time  $t_M$  to 0 s. These values must not be changed.
- ▷ Once the wiring is complete, close the BCU again. Ensure that the upper housing section is not inclined when being replaced on the lower housing section.

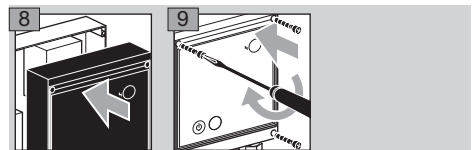

- ▷ To guarantee that the burner control unit complies with enclosure IP 54, make sure that the screws are tightly secured after wiring and that the cable glands are closed.
- 10 Switch on the power supply.
- 11 Release the gas supply.

## Commissioning

- ▷ The heater may only be commissioned once it has been ensured that the heater, gas pipes, mains voltage supply and room thermostat have been installed by authorized trained personnel according to the regulations.



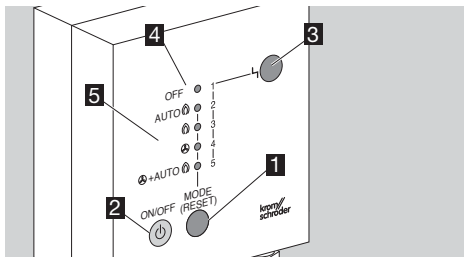

- 1 Switch on the power supply.
- 2 Release the gas supply.

### Part designations



- 1 MODE/RESET selection button
- 2 BCU On/Off switch
- 3 Red lamp lights up if a fault is pending
- 4 Operating mode LED: Off
- 5 LEDs for selectable operating modes

- ▷ The BCU is operated using two buttons: using the ON/OFF button , the heater is switched on and off. By pressing the MODE selection button for > 1 s, it is possible to switch between the different operating modes.

Operating mode	Explanation
AUTO 	BCU waits for the signals for controlled air flow or heating.
	Heating (continuous operation)
	Controlled air flow (continuous operation)
 + AUTO 	Controlled air flow (continuous operation) and heating when thermostat signal is applied

### Switching on

- 3 Switch on the burner control unit. Press ON/OFF  until an LED lights up.
- ▷ The BCU switches on in the last operating mode selected.
  - ▷ The heater starts once the set switch-on delay time  $t_E$  has elapsed, see page 5 (Adjusting the switch-on delay  $t_E$ ).
  - ▷ The burner starts after the safety time of 5 s has elapsed and operates in the selected operating mode.
  - ▷ The operating mode can be changed using the MODE selection button. The selected operating mode is only activated once the device has been in this position for at least 3 s. It is thus possible to "scroll" through the different operating modes.

### Switching off

- 4 Switch off the heater. Press ON/OFF . The LED next to "OFF" lights up and the burner switches off after 3 s. Mains voltage is still supplied however.
- ▷ The fan cools the heater down until it reaches switch-off temperature.

### Faults

- ▷ Flashing LEDs signal the cause of a fault, see page 9 (Assistance in the event of malfunction).
- ▷ In the first 4 s after switching on the power supply or pressing the ON/OFF button , an operating mode is not yet active. Within these 4 s, a new operating mode can be selected. As soon as the MODE selection button has been pressed and a new operating mode has been selected, the 4 s are extended accordingly.
- ▷ If a fault has occurred, it is displayed immediately, but 4 s are also available here during which a new operating mode can be selected.

## Adjusting the heater

### Burner gas pressure $p_G$

$p_U$  = Inlet pressure

$p_G$  = Gas pressure on the burner

- ▷ The gas pressure on the burner is adjusted using  $p_G$  on the combination control.

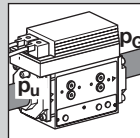

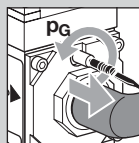

- ▷ For this, the outlet pressure  $p_G$  must be measured on the combination control.

- 1 Disconnect the system from the electrical power supply. The mains plug may only be pulled out once the device has been switched off and post-cooling is complete.
- 2 Shut off the gas supply.
- 3 Open the test nipple.

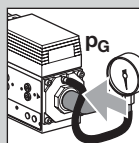

- 4 Connect a pressure gauge with display range 10 to 50 mbar.



- 5 Switch on the power supply.
- 6 Release the gas supply.
  - ▷ The inlet pressure  $p_i$  must comply with the technical data, see page 17 (Technical data).
- 7 Switch on the burner control unit. Press the ON/OFF button  until an LED lights up.
- 8 Select the Heating  operating mode.
- 9 Let all heaters burn for at least 20 s.
  - ▷ The required gas pressure on the burner depends on the lower calorific value/Wobbe index.
- 10 Select the required gas pressure on the burner from the table.

	Lower calorific value [MJ/m <sup>3</sup> ]	Wobbe index	[mbar]
Natural gas L G 25	32.49	41.53	13.3
Natural gas H G 20	37.78	50.71	9.1
LPG G 30	125.81	87.34	22.2

- ▷ Converting the lower calorific value/Wobbe index to kWh/m<sup>3</sup>:

$$\text{kWh/m}^3 = \frac{\text{Lower calorific value/Wobbe index [MJ/m}^3\text{]}}{3.6}$$

- ▷ Always use a pressure gauge to adjust the burner gas pressure. The white scale on the adjusting screw may differ.



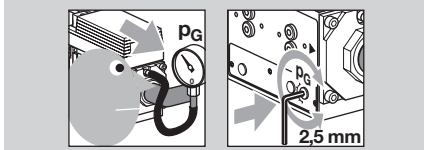

- 11 If all heaters are heating at the same time, compare the required gas pressure on the burner with the gas pressure  $p_G$  read off the pressure gauge, adjust it and monitor the pressure gauge.



### Flame signal

- ▷ The flame signal is displayed for 20 s.
- 12 Check the flame signal.
  - ▷ For adjustment and maintenance work, the flame signal can be displayed.
  - ▷ Display of the flame signal starts when the selection button is pressed and within 1 s (almost simultaneously), ON/OFF  is pressed, too.

- = LED is constantly lit
- = LED flashes

	μA										
	2	3	4	6	8	10	12	14	16	18	20
OFF ○ 1											●
AUTO  2									○	●	●
 3						○	●	●	●	●	●
 4				○	●	●	●	●	●	●	●
 + AUTO  5	○	●	●	●	●	●	●	●	●	●	●

- ▷ The flame signal is sufficient when 2 LEDs are constantly lit and the third LED flashes.
- ▷ If the flame signal is not sufficient, see page 9 (Assistance in the event of malfunction).

- 13 Monitor combustion.

- ▷ The flame must be blue and must remain inside the device.
  - ▷ If the burner pressure  $p_G$  and flame signal have been checked and adjusted on all devices, the system operates correctly.
- 14 Remove the pressure gauge.

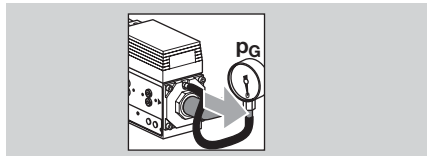

- 15 Close the test nipple.

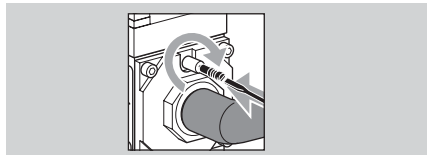

## Installing the protective caps

### Burner control unit

- 1 Pull the opened protective cap from the top over the burner control unit. In doing so, pull the edges of the protective cap apart.

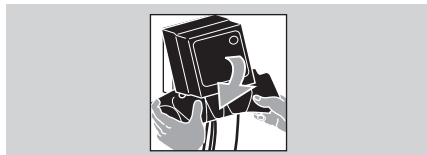

- 2 Slide the opened edges of the protective cap into the gap between the burner control unit and the mounting plate.

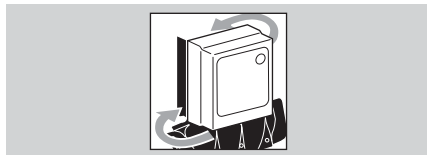

- ▷ When it becomes difficult to move the edges of the protective cap, this means the material has turned cold and hard. The protective cap will become soft again when it is heated briefly.
- 3 Hold the ends of the protective cap on the back of the burner control unit together and close the push-in rivets.



## Gas combination control

- 1 First, pull the opened protective cap over the gas inlet on the gas combination control.

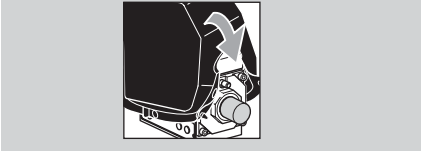

- 2 Then pull the right-hand side of the protective cap over the gas outlet.

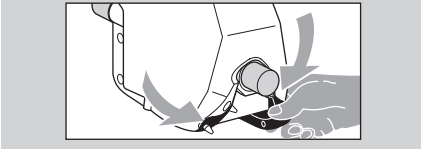

- 3 Hold together the ends of the protective cap on the underside and close all the rivets.

## Cleaning

### ! CAUTION

To ensure that no damage occurs during operation and cleaning, please observe the following instructions. Otherwise, injuries or damage to the device may occur and/or the function of the device may be impaired, and the manufacturer's warranty will be cancelled.

- Sharp-edged metal sheets. Always wear protective gloves.
- After cleaning, check that the components on and in the heater are in good condition. The device may only be restarted if all safety devices have been installed and the safety functions have been checked.
- Clean the heater once a year when used in horticulture and at regular intervals as well as after each fattening period when used in agriculture, as described below. Inadequate or irregular cleaning can cause damage to the device or lead to fire damage. For example, dirt particles can catch fire and can be blown out of the device.

- 1 Switch off the burner control unit BCU.
- 2 Disconnect the system from the electrical power supply. The mains plug may only be pulled out once the device has been switched off and post-cooling is complete.
- 3 Shut off the gas supply.

- ▷ If the burner control unit and the gas combination control are not equipped with protective caps, we recommend cleaning the heater with compressed air or a damp cloth only.

- ▷ Equipping the burner control unit BCU and the gas combination control CG with a protective cap allows the devices to be cleaned carefully with a water jet/high-pressure cleaner during cleaning/disinfection of the animal shed.
- ▷ To guarantee that the burner control unit complies with enclosure IP 54, make sure that the screws are tightly secured after wiring and that the cable glands are closed.
- ▷ The distance between the nozzle and the surface to be cleaned must always be at least 50 cm.

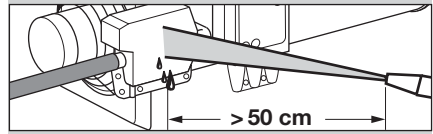

- ▷ Do not direct the water jet straight at electrical components such as the vane.
- ▷ The water jet from the high-pressure cleaner can cause serious damage to the components in the heater. For example, the vane can be bent or other parts such as the spark plug or rubber seals can be displaced. Avoid direct contact.
- ▷ Do not spray the edges of the protective cap which are closed using push-in rivets only or the connection between the burner control unit and the mounting plate directly with water, high-pressure cleaning equipment or chemical cleaning agents.



- ▷ Do not spray water or chemical cleaning agents directly into the space between the fan shaft/impeller wheel and motor and do not clean with high-pressure cleaners.

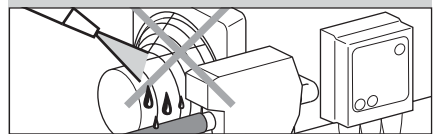

- ▷ Chemical cleaning agents, disinfectants and/or pesticides contain corrosive substances which can even corrode stainless steel. Always rinse the devices with water after cleaning using such agents to remove any residue of these agents from the surface.



- ▷ Loosen the screw connection on the grille just enough to be able to move the screw connection to the side.

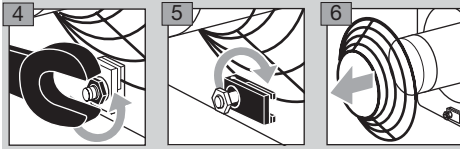

- 7** Clean the grille.
- 8** Clean the fan using a cloth.

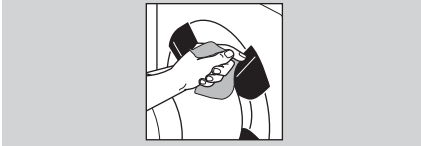

- 9** Clean the interior of the device carefully using air.
  - ▷ The vane must not be bent.
- 10** Check that the vane switch is functional.
  - ▷ If the vane is moved a little in the direction of the arrow, a quiet click can be heard. This means that the switching path is correct.

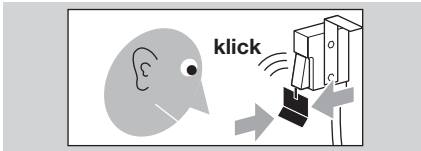

### Assembly

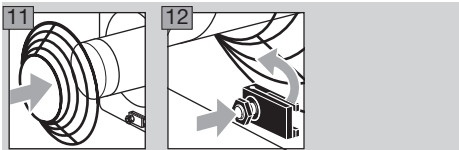

- ▷ Check the burner is functioning faultlessly in normal operation, see page 14 (Checking the safety functions and burner operation).
- 13** When operating with propane, check that the breather orifice of the pressure reducer on the connection kit is clean.

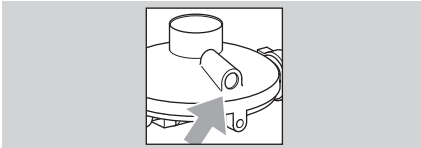

## Assistance in the event of malfunction

### ⚠ WARNING

To avoid harm to persons and animals or damage to the heater, please observe the following:

- Electric shocks can be fatal! Before working on possible live components, ensure the unit is disconnected from the power supply.
  - Fault-clearance must only be undertaken by authorized trained personnel!
  - Repairs to components, e.g. the burner control unit BCU or the combination control CG, may only be carried out by the manufacturer. Otherwise, the guarantee will be cancelled. Unauthorized repairs or incorrect electrical connections, e.g. the connection of power to outputs, can cause gas valves to open and the burner control unit to become defective. In this case, fail-safe operation can no longer be guaranteed.
  - (Remote) resets may only be conducted by authorized personnel with continuous monitoring of the devices concerned.
- ▷ In the event of an installation fault, the burner control unit closes the gas valves and the red LED on the burner control unit lights up. Then, the fault is indicated by a combination of flashing yellow LEDs which are numbered from 1 to 5.
  - ▷ Faults may be cleared only using the remedies described below.
- 1** Press the reset button on the BCU to reset it. The unit then reverts to the last operating mode selected.
- ▷ Faults marked with an \* are warnings. Provided that a restart has been programmed, they are no longer displayed if the cause of the fault has been remedied. It is not necessary to press the reset button when these messages are displayed.
- 2** If the burner control unit does not respond even though all faults have been remedied, remove the unit and return it to the supplier.

- ? **Fault**
- ! **Cause**
- **Remedy**

## Possible faults and suggested solutions

### ? LED 1 flashes.

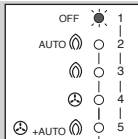

- ! Pressure switch does not switch.
- Check inlet pressure  $p_U$ .
- ! Gas pressure on the burner too low.
- Readjust gas pressure  $p_G$  on the combination control, see page 6 (Adjusting the heater).
- ! Fuse F2 defective.
- Replace fuse (3.15 A, slow-acting, H). Ensure that only one heater is directly wired to the thermostat, see page 3 (Wiring).

### ? LED 2 flashes.

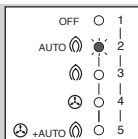

- ! Vane switch does not switch off during the “no flow” state check on burner start-up.
- Check that the vane switch is functional, see page 12 (Maintenance).

### ? LED 3 flashes.

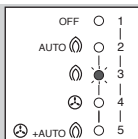

- ! The vane switch has not switched on 25 s after the fan has been switched on.
- Vane, fan or grille are dirty. Clean, see page 12 (Maintenance).
- Fuse F1 defective (8 A, slow-acting, H). Check the function of the fan and replace fuse F1 if necessary.
- ! Motor defective.
- Remove the device and return it to the supplier.

### ? LED 4 flashes.\*

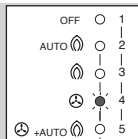

- ! On burner start-up, the BCU has not detected a flame during the safety time. In the parameter “Number of start-up attempts”, it is possible to program up to three start-up attempts. If one of the further start-up attempts is successful, fault signalling stops automatically once the post-purge time has elapsed.
- Ignition is not working properly. Clean the spark electrode and check for correct distance, see page 12 (Maintenance). Check the connection of the ignition cables for damage or moisture. The spark plug must be fitted correctly. Check the ignition spark optically and acoustically from the fan side during the 4-second ignition time.
- Poor flame signal due to incorrect burner adjustment. Readjust gas pressure  $p_G$ , see page 6 (Adjusting the heater).
- Poor flame signal due to dirty/badly connected flame rod. Clean the flame rod and check for correct distance, see page 12 (Maintenance). Check the cable connection, cable and plug for damage or moisture. The plug must be fitted correctly. Check the yellow and green burner ground cable for corrosion and to ensure it is firmly connected.
- Air in the gas pipe. Vent the gas pipe.
- Valves do not open. Remove the valve plug on the combination control CG and measure the voltage between L1 and N during the safety time. If the voltage is not adequate, first replace the CG and return it to the supplier. **Attention!** Only commission the new BCU once the short-circuit or fault on the valve output of the CG has been remedied. Otherwise, the new BCU will be damaged.
- If the fault continues to be signalled, there may be a short-circuit on the valve output. Return the burner control unit to the manufacturer for inspection.
- Short-circuit on ignition output. Replace fine-wire fuse F2: 3.15 A (slow-acting, H) and check the safety function, see page 14 (Checking the safety functions and burner operation).

### ? LED 5 flashes.

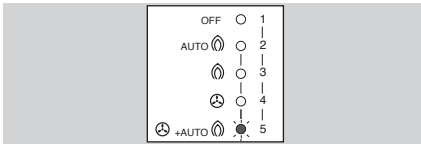

- ! Signal from safety temperature limiter (STL). Temperature has been exceeded.
- No fan run-on due to soiling. Clean, see page 12 (Maintenance).
- ! Fan defective.
- Check function of fan.

### ? LEDs 4 and 5 flash.\*

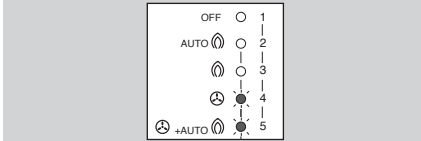

- ! Signal from safety temperature monitor (STM). Temperature has been exceeded.
- Leave heater to cool down for longer.
- No fan run-on due to soiling. Clean, see page 12 (Maintenance).

### ? LEDs 3 and 5 flash.\*

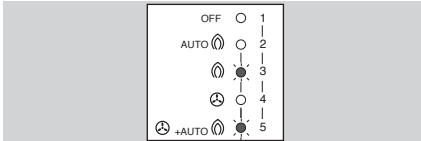

- ! During three consecutive restarts, the gas pressure switch has tripped during the safety time or flame proving period (gas pressure switch oscillates).
- Inlet pressure fluctuates. Establish stable gas supply.
- Gas pressure  $p_G$  too low. Readjust gas pressure  $p_G$ , see page 6 (Adjusting the heater).

### ? LEDs 2 and 5 flash.

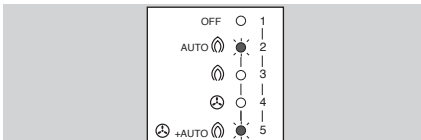

- ! Incorrect flame signal through conductive ceramic insulation, e.g. surge via PE wire, possible.
- Remedy incorrect flame signal. Replace flame rod and, if necessary, the BCU as well.

### ? LEDs 1 and 5 flash.\*

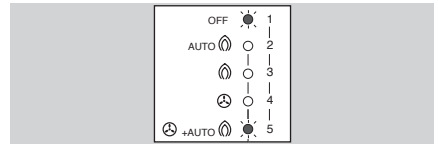

- ! Temperature sensor is not functioning correctly.
- Check the temperature sensor connection.
- Temperature sensor is below  $-20^{\circ}\text{C}$ .
- ! Temperature sensor defective.
- Replace the temperature sensor.

### ? LEDs 3 and 4 flash.\*

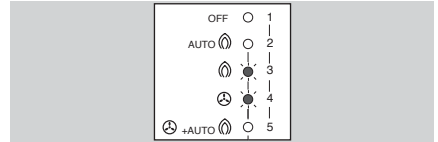

- ! The time (cycle lock) between two starts is too short.
- The BCU ensures there is a pause of 15 s between the starts. This warning is displayed during this time.

### ? LEDs 2 and 4 flash.\*

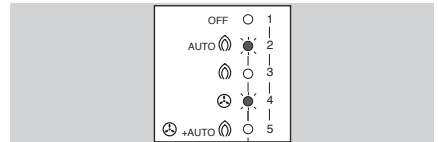

- ! The flame has gone out during operation. If a restart has been programmed, an automatic restart is carried out provided that the burner has been in operation for at least 2 s beforehand.
- Poor flame signal due to incorrect burner adjustment. Readjust gas pressure  $p_G$ , see page 6 (Adjusting the heater).
- Poor flame signal due to dirty or badly connected flame rod. Clean the flame rod and check for correct distance, see page 12 (Maintenance).
- Check the cable connection for damage or moisture. The plug must be fitted correctly.
- Check the yellow and green burner ground cable for corrosion and to ensure it is firmly connected.

## ? LEDs 1 and 4 flash.\*

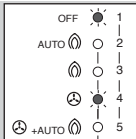

! A signal is applied for longer than 10 s to the remote reset input (terminals 31 and 32) (permanent remote reset).

- Remote reset must only be used to reset the device.

## ? LEDs 1 and 3 flash.

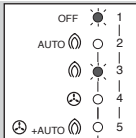

! The flame has not gone out within 5 s of the burner being switched off. The gas valve does not close correctly.

- Shut off the gas supply to the device. Check the burner and gas valves for correct function, see page 14 (Checking the safety functions and burner operation).

## ? LEDs 1 and 2 flash.\*

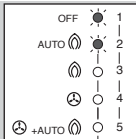

! The power supply has suffered a fault.

- Ensure there is sufficient mains voltage, see page 17 (Technical data).

## ? LEDs 3, 4 and 5 flash.

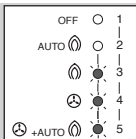

! While a fault was pending, more than 5 attempts were made within 15 minutes to reset the device using the remote reset input (terminals 31 and 32).

- Reset is only possible using the reset button on the BCU.

## Maintenance

### ! CAUTION

To ensure that no damage occurs during operation and maintenance, please observe the following instructions. Otherwise, injuries or damage to the device may occur and/or the function of the device may be impaired. The supplier/manufacturer cannot accept liability for damage resulting thereof.

- Have the heater cleaned at least once a year by qualified maintenance personnel.
- Have the safety functions checked at least once a year by qualified maintenance personnel, see page 14 (Checking the safety functions and burner operation).
- Sharp-edged metal sheets. Always wear protective gloves.
- After cleaning or repair work, check that the components on and in the heater are in good condition. The device may only be restarted if all safety devices have been installed and the safety functions have been checked, see page 14 (Checking the safety functions and burner operation).

- 1 Switch off the burner control unit BCU.
- 2 Disconnect the system from the electrical power supply. The mains plug may only be pulled out once the device has been switched off and post-cooling is complete.
- 3 Shut off the gas supply.

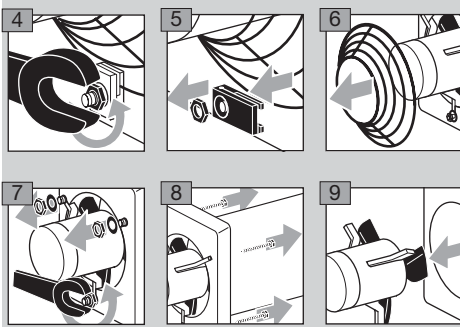

- 10 Clean the grille with a cloth.
- 11 Clean the interior of the device carefully using air. The vane must not be bent.
- 12 Clean the fan and vane using a cloth.

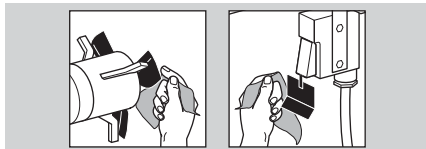

- 13 Check that the vane switch is functional.

- ▷ If the vane is moved a little in the direction of the arrow, a quiet click can be heard. This means that the switching path is correct.

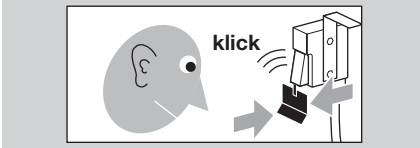

- ▷ Check the nozzle and burner baffle plate for dirt and if necessary, clean using a cloth. Remove first the burner baffle plate, then the nozzle. To do this, a special tool is required. Nozzle spanner size = A/F 35. The nozzle is secured via the burner baffle plate by a cross-head screw.

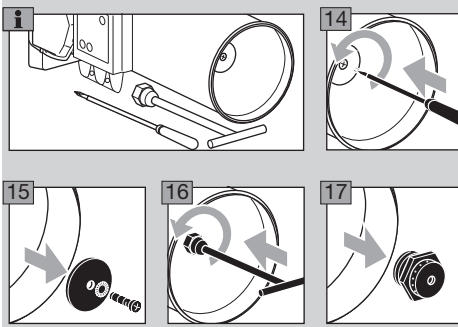

- ▷ The spark electrode and flame rod can be removed without having to dismantle the burner chamber.

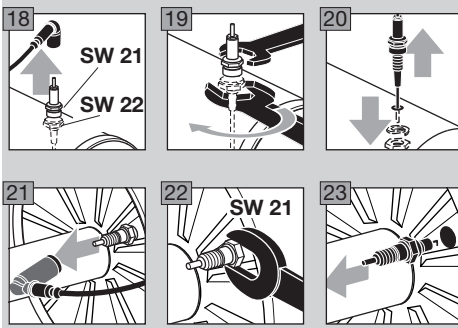

**24** Check the electrodes for dirt and if necessary, clean using a cloth. Remove stubborn dirt on the electrode rod using fine abrasive paper.

**25** Check electrode and porcelain insulator for cracks and replace the electrode in case of damage.

- ▷ Replace the electrodes if necessary.
- ▷ Fit the electrode seal.

**26** Clean the plates for the air intake using a cloth.



### Assembly

- ▷ Ensure that the rubber seals between the electrodes and the terminal boots are fitted correctly.

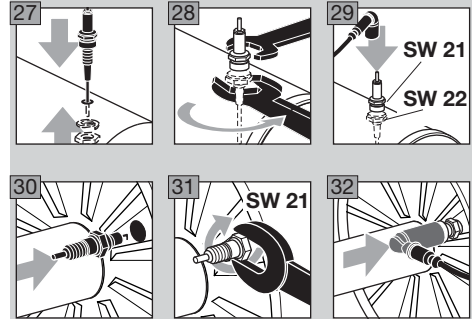

- ▷ Ensure the electrodes are at the correct distance from one another and correctly positioned as regards the nozzle.

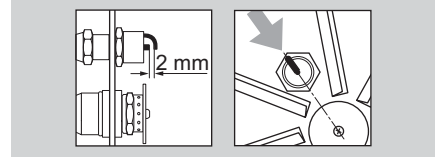

- ▷ The device may only be restarted if all safety devices have been installed.

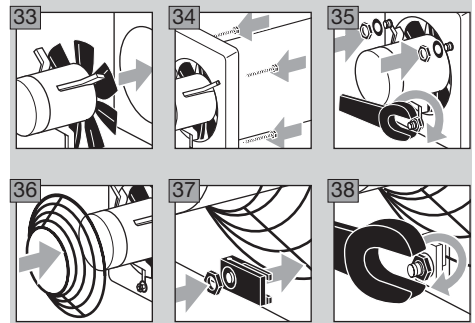

**39** Check the safety functions before commissioning, see page 14 (Checking the safety functions and burner operation).

## Checking the safety functions and burner operation

### **⚠ WARNING**

If these checks are not carried out, the gas valves might remain open allowing non-combusted gas to escape. Risk of explosion!

#### **Safety functions**

- 1** Switch off the heater during operation. Press ON/OFF .
  - ▷ The flame goes out < 1 s.
  - ▷ The fan cools the heater down until it reaches switch-off temperature.
- 2** Remove the valve plug on the combination control during operation.
  - ▷ The gas valves close < 1 s.
  - ▷ The flame goes out.
  - ▷ The burner control unit BCU displays the fault message "The flame has gone out during operation". LEDs 2 and 4 flash.
  - ▷ If a restart has been programmed, the burner control unit will initially attempt to restart and will then perform a fault lock-out. LED 4 flashes and indicates the fault message "No flame has been detected during the safety time".
- 3** Shut off the inlet pressure during operation.
  - ▷ The pressure switch in the combination control switches because the supply pressure is too low.
  - ▷ The burner control unit performs a safety shutdown: the gas valves are disconnected from the electrical power supply.
  - ▷ The flame goes out.
  - ▷ The burner control unit BCU displays the fault message "Supply pressure too low". LED 1 flashes.
  - ▷ If the burner control unit responds in a different way to that described, a fault has occurred, see page 9 (Assistance in the event of malfunction).

### **! CAUTION**

The fault must be remedied before the system may be operated.

#### **Checking burner operation**

- 1** Switch on the BCU.
- 2** Select the Heating  operating mode.
- 3** Allow the burner to burn for 15 minutes.
- 4** During this time, monitor the flame pattern.
  - ▷ The flame must be blue.
  - ▷ No dirt particles must come out of the heater.

#### **Accessories**

##### **Room thermostat**

Use a room thermostat with a hysteresis of  $\pm 1^\circ\text{C}$ , 230 V, Type TH 215.

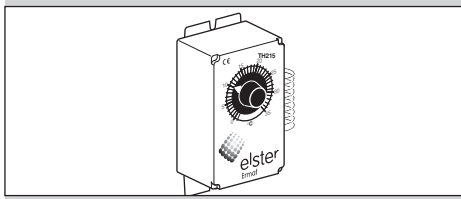

Order No.: N50260145

##### **Pressure reducer**

Pressure reducer for LPG.

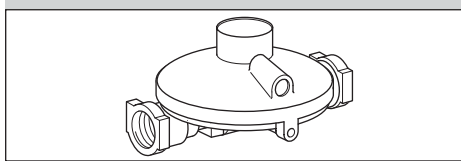

RECA 1.5 bar to 50 mbar, 2 x 1/2" internal thread connection, 10 kg/h, Order No.: N52600023.

##### **Manual valve**

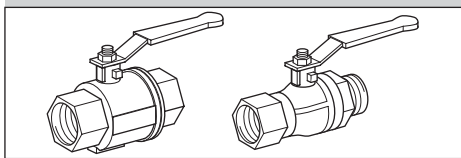

2 x 1/2" internal thread connection,  
Order No.: N52600019.

1/2" internal and external thread connection,  
Order No.: N52600027.

### Connection kit for natural gas

Manual valve and gas hose to connect the gas combination control CG to the gas supply.

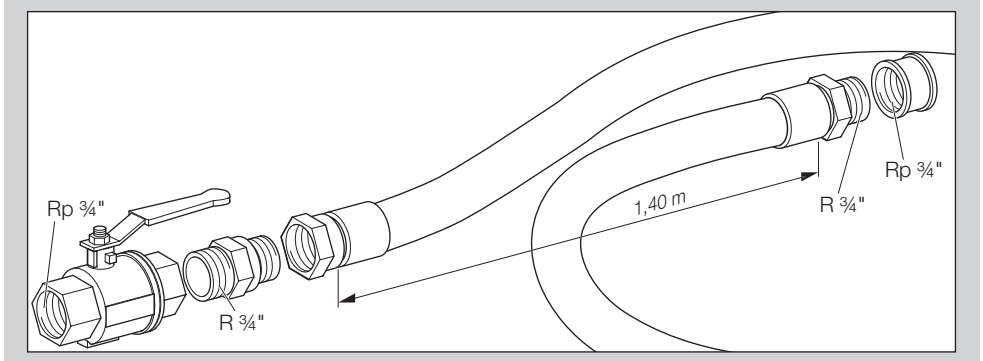

Connection kit: Rp 3/4" threaded connection, total length = 1.50 m, Order No.: N52600072

### Connection kit for propane

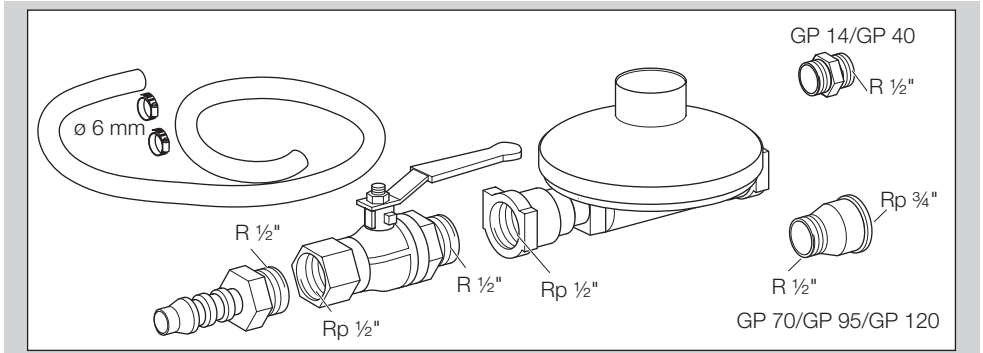

Pressure reducer, manual valve, hose (length = 2 m), 2 hose clamps, R 1/2" double nipple for GP 14/GP 40, R 1/2"-Rp 3/4" reducing fitting for GP 70-GP 120, to connect the gas combination control CG to the gas supply, Order No.: N52600025

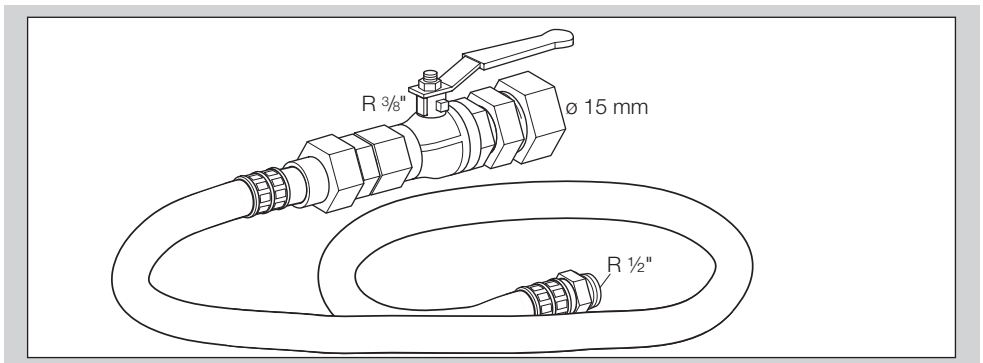

Manual valve and hose (DVGW certified, length = 2 m) to connect the gas combination control CG to the gas supply, Order No.: N52990209

## Spare parts

- ▷ When ordering spare parts, please quote the order number along with the designation and item no. of the spare part as well as the heater serial number.
- ▷ When ordering spare parts which are not listed here below, please quote the edition of these operating instructions and the heater serial number.
- ▷ Use original spare parts only to ensure the replacement complies with the requirements stipulated by the manufacturer.

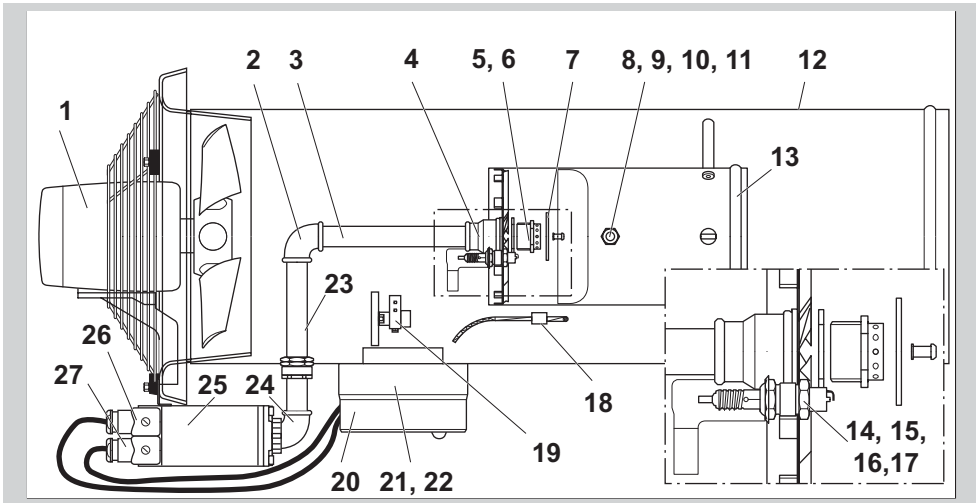

Item	Order No.	Designation
1	N50260401	Multifan fan, complete, 50 Hz, 7 µF motor, 40° impeller wheel, 2E30-3PP
	N50261401	Multifan fan, complete, 60 Hz, 5 µF motor, 30° impeller wheel, 2E30-3PP
2	N50260013	90° elbow, galvanized, Rp ¾"
3	N50260042	Pipe 230 mm, galvanized, R ¾"
4	N50260080	Reducing socket, galvanized, Rp ¾ – 1", No. 240
5	N50260020	LPG nozzle for GP 70, 6 x Ø 1.9 mm
6	N50260152	Natural gas nozzle for GP 70, 12 x Ø 2.3 mm
7	N50260168	Burner baffle plate for GP 40/GP 70, Ø 62 mm
8	N50260004	M14 x 1.25 nut for spark electrode and flame rod
9	N50260031	Beru ZE14 flame rod for GP 40/GP 70
10	N50260130	Terminal boot for flame rod, rubber, black
11	N50500080	Ionization cable kit for GP series, incl. plug and seal
12	N50260111	GP 40/GP 70 housing, stainless steel
13	N50260115	Burner chamber for GP 40/GP 70
14	N50260004	M14 x 1.25 nut for spark electrode and flame rod
15	N50260030	Beru spark plug for GP 40/GP 70, RGA 100
16	N50260039	Terminal boot for spark electrode, metal, grey, interference-suppressed, Beru, 1 kΩ, 0300251101
17	N50260213	Ignition cable kit for GP 40–GP 120, complete with plug and cap
18	N50260098	Temperature sensor for STM/STL, 6 x 45, L = 450 mm, TSK 1056 NTC (5 kΩ/25°C)
19	N50260144	Vane switch, complete, universal for all devices, incl. 2-core cable
20	N50260101	BCU 300 upper housing section, incl. electronics, Kromschroder THP-GW 84636001
21	N50260102	BCU 300 lower housing section, incl. ignition transformer
22	N50260109	Ignition transformer for gas, Eichhof E4718/55, 1-pin
23	N50280202	Pipe 100 mm, galvanized, R ¾"
24	N50260171	90° male/female elbow, galvanized, R ¾"/Rp ¾"
25	N50280123	Gas combination control CG 220 for GP 70–GP 120, Kromschroder CG 220R01-DT2WF1Z
26	N50260119	Plug for pressure switch, grey
27	N50260118	Plug for valves, black
28	N50260147	Protective cap for BCU, PVC, black, with viewing window
29	N50260148	Protective cap for gas combination control CG 220, PVC, black



## Technical data

Inlet pressure  $p_U$ :  
natural gas: 20–25 mbar,  
propane: 35–50 mbar.  
Setting of the gas pressure switch  $p_W$ :  
natural gas: 10 mbar,  
propane: 30 mbar.  
Gas connection: R ¾" external thread.  
Material:  
casing: stainless steel 430,  
burner chamber: stainless steel 430,  
BCU: PPE.  
Ambient temperature:  
-10 to +60°C. No condensation permitted.  
Storage temperature: -20 to +50°C.  
Cycle lock: 15 s.  
Capacity: 70 kW.  
Gas consumption:  
natural gas L:  $\pm 7.2 \text{ m}^3/\text{h}$ ,  
natural gas H:  $\pm 6.1 \text{ m}^3/\text{h}$ ,  
propane:  $\pm 5 \text{ kg/h}$ .  
Connection rating:  
230 V AC, -15/+10%, 50/60 Hz, 400 W.  
Current consumption:  $I_A/I_N$ :  $\pm 3.6 \text{ A}/1.7 \text{ A}$ .  
Air circulation:  
Controlled air flow:  $\pm 3875 \text{ m}^3/\text{h}$ ,  
Heating:  $\pm 4500 \text{ m}^3/\text{h}$ .  
Jet length: 50 m.  
Housing:  
length: 1200 mm,  
width (total): 530 mm,  
height/diameter: 440 mm,  
weight: 27 kg.

## Declaration of conformity



We, the manufacturer, hereby declare that the product GP complies with the requirements of the listed Directives and Standards.

Directives:

- 2009/142/EC
- 2004/108/EC
- 2006/42/EC
- 2006/95/EC

Standards:

- DIN 3362, EN 298
- EN 60730
- EN 1643, EN 525:2009

The relevant product corresponds to the type tested by the notified body 0085.

The production is subject to the surveillance procedure pursuant to Directive 2009/142/EC Annex II paragraph 3.

Elster-Instromet B.V.

Scan of the Declaration of conformity (D, GB) – see [www.docuthek.com](http://www.docuthek.com)

## Logistics

### Transport

Protect the unit from external forces (blows, shocks, vibration). On receipt of the product, check that the delivery is complete, see page 2 (Part designations). Report any transport damage immediately.

### Storage

Store the product in a dry and clean place.  
Storage temperature: see page 17 (Technical data).  
Storage time: 6 months before using for the first time. If stored for longer than this, the overall service life will be reduced by the corresponding amount of extra storage time.

### Packaging

The packaging material is to be disposed of in accordance with local regulations.

### Disposal

Components are to be disposed of separately in accordance with local regulations.